



PRL

GLASS
SYSTEMS
www.prlglass.com

Aluminum
ARCHITECTURAL PRODUCTS
www.prlaluminum.com

Page

- PRL Panic Devices 1
- PD Exterior Handles 2
- Fittings 4
- Configurations 5
- Deadbolts 6
- TVS Headers 7
- Custom Lock Pulls 8
- Easy Lock Ladder 10
- EZ Touch Handle 12
- Custom Pulls 13
- DT Pulls 14
- Ladder Pulls 15
- Standard Pulls 16
- Full Frame Doors 17
- Door Hardware 18
- PRL Systems 23-32

Entrance Doors, Panic Devices & Hardware



All Glass & Metal Products
are **Designed/Engineered &
Manufactured in house**

a Dynamic Company
with 23 years of proven results!

Panic Devices/Egress controls

● **Larger**



● **Stronger**



● **Innovative**



● **Faster**

- 3 Days Std. Leadtime
- Next Day Service*

● Crate/Freight available to any part of the U.S. / International

* consult PRL for details



Panic Devices/Egress controls



Full Frame Style Door with PL-100 Panic Device with exterior key access/FS handle.



A Style Door with PL100 Panic Device/ D exterior handle



BP Style Door with PL100 Panic Device/ B exterior handle



P Style Door w/ PL100 Panic Device/ A exterior handle



FF Style Door w/ PL100 Panic Device/ A exterior handle

PRL manufactures the PL-100 series panic device. This panic is a contemporary design offered primarily for all glass door entrance systems. The slim 1 1/4" dia. interior bar conceals the latching mechanism allowing minimal uninterrupted view on 1/2" or 3/4" glass. With the strict American with Disabilities (A.D.A.) code this makes the PL-100 the right choice for installers. PRL panics have been tested in accordance to the American National Standard for Exit Devices, ANSI/BHMA A 156.3-2008, Grade 1 certified and UL305, standard safety for panic devices.

PL-100 devices can also be dogged by sliding a pin located below the cylinder housing which allows the panic to remain in an open position giving free access during business hours. An electric strike can also be utilized with this device to work in conjunction with a remote keyless application.

Available finishes:

- Polished or Satin Stainless Steel
- Oil rubbed bronze
- Polished or Satin Brass
- Powder Coat Paint

Panics can be manufactured to be installed on wood and aluminum doors, please consult factory.

Panic Device/Deadbolt Exterior Handles

PRL Panic Device exterior handles are available in All Industry standard styles from A to Y.

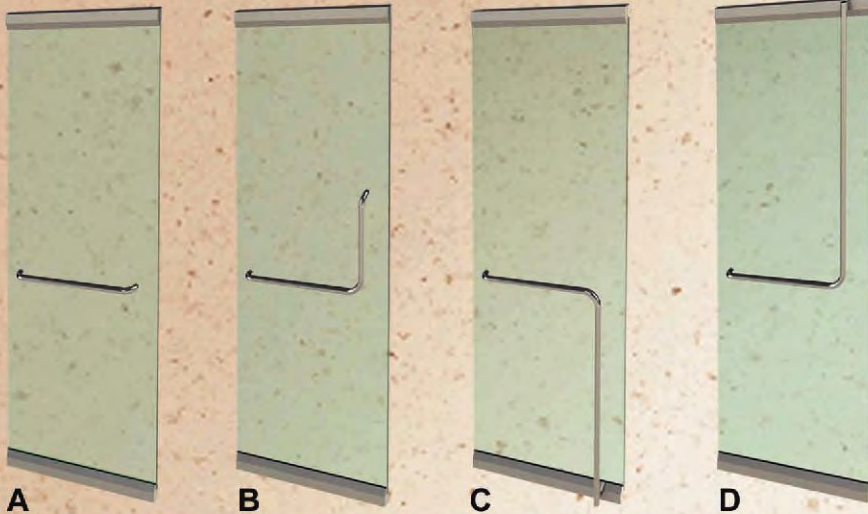

Narrow Style Aluminum Door with PL100A Panic Device.



P Style Door with PL-100 Panic Device and Custom Square Bar/Dual Tone Finish FS exterior handle

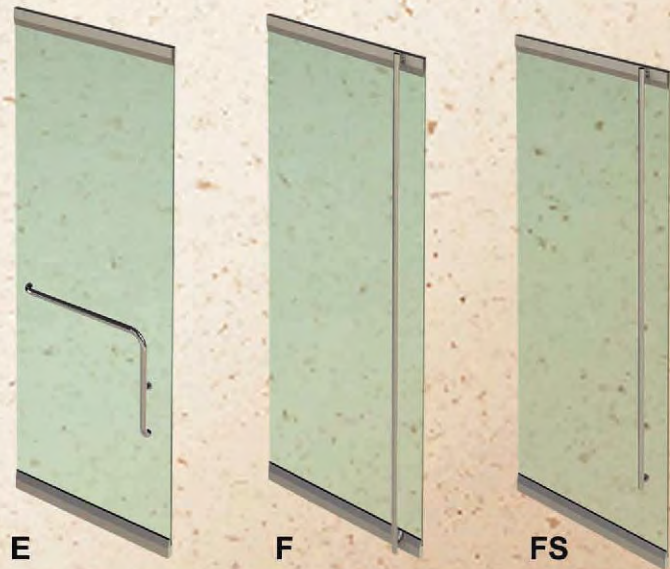

Available metal finishes are stainless steel (satin or polished) and custom finishes upon request. Consult us for details.

Most popular styles are shown, to view our full line visit prlglass.com

**Panic Device/
Deadbolt
Exterior Handles**



G



H

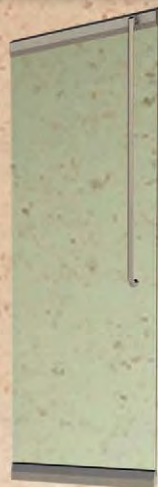

J



JS



K



KS



L



LS



M



MS



N



P



X-Y

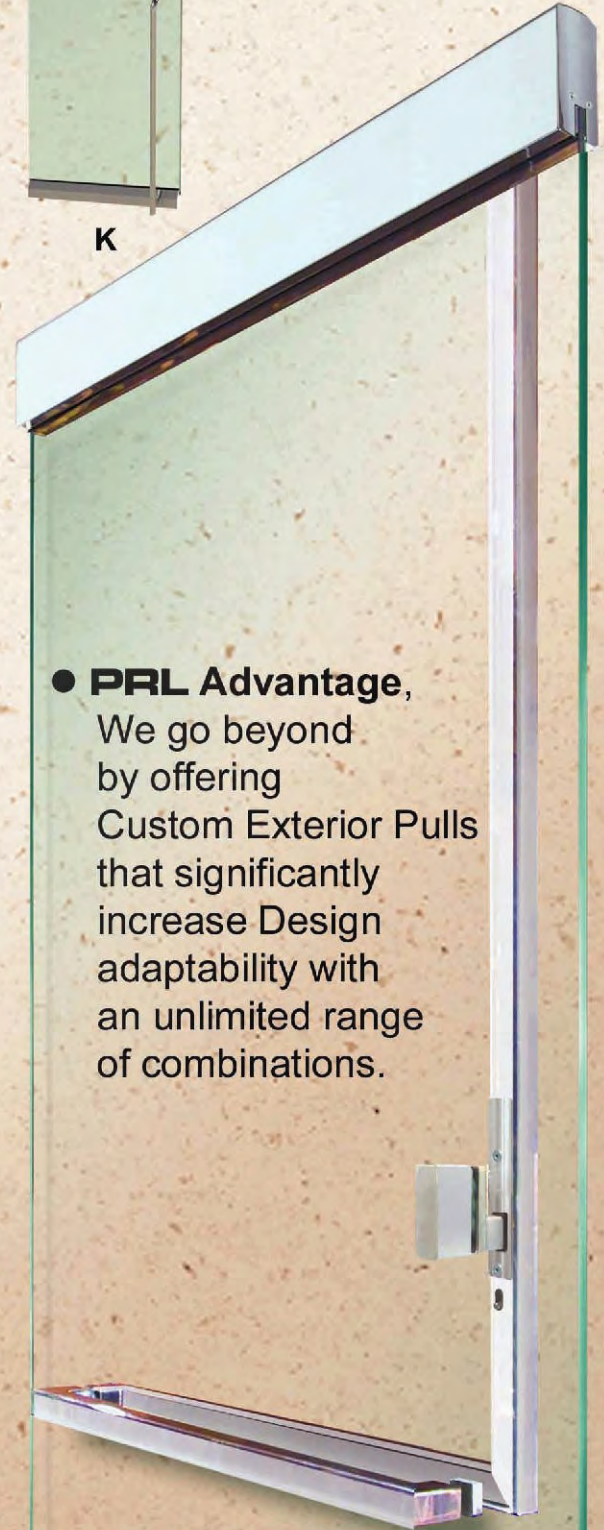

● **PRL Advantage,**
We go beyond
by offering
Custom Exterior Pulls
that significantly
increase Design
adaptability with
an unlimited range
of combinations.

Fittings



BP Style Doors/ TVS System



1- DOOR STOP/STRIKE

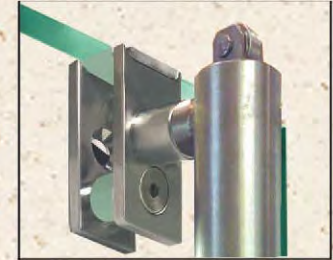

2- GLASS MOUNT BRACKET



3- RAIL MOUNT BRACKET



4- PD ACTUATOR



5- CYLINDER HOUSING

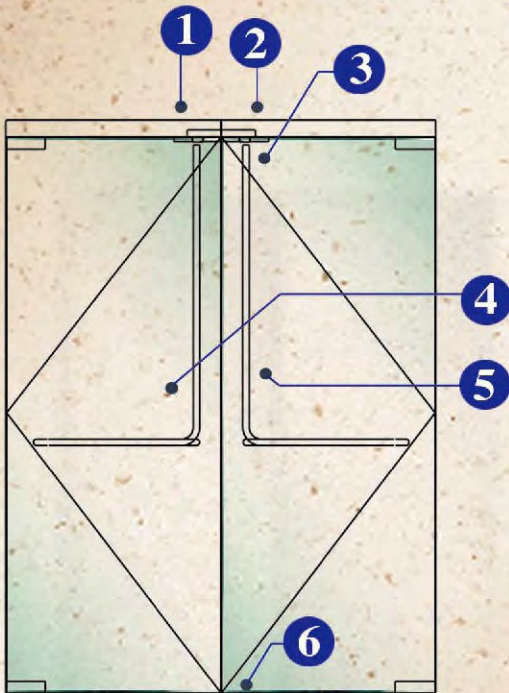

PRL **Panic Devices** minimal tubular housing accommodate over 100 precision manufactured components engineered and mechanically synchronized for a safe panic function.

Various modular Fittings are offered as separate options to make panic applications versatile. Range from mechanical strikes to remotely operated access/egress electric controls.

Custom modifications available upon request*

*some limitations may apply

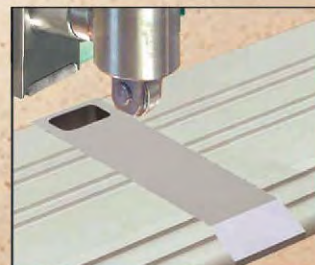

6b- T-HOLD STRIKE (PL 110 ONLY)



6- FLOOR STRIKE (PL 110 ONLY)

* State/local building codes may require doors bottom full rail.

Panic Device Configuration/ Specifications

PRL manufactures two types of panic devices PL-100 for top latch and PL-110 for floor latch application.

- Exterior handles
Std. Styles/Custom
- Lock Options
Cylinder/Lock housing,
mechanical/electric strikes
- Mount type hardware
Glass/Metal
- Door applications
All glass, Full frame Glass,
Storefront aluminum & wood

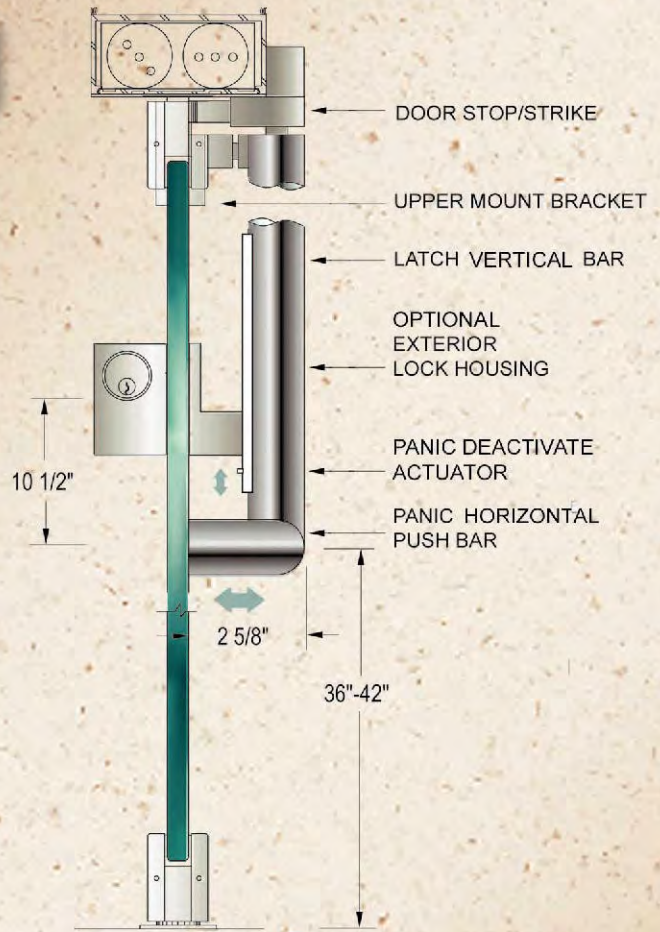

PL SERIES PANIC HANDLE GLASS MOUNT SHOWN

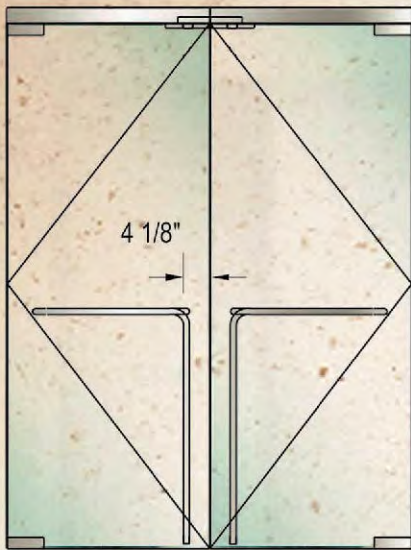

PL-110

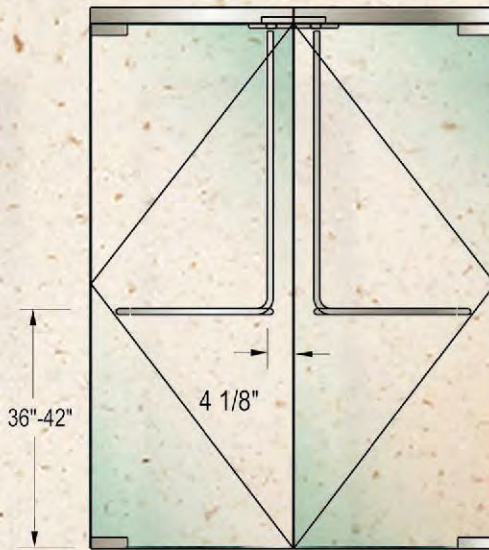

PL-100

RECOMMENDED DOOR SIZES:

GLASS THICKNESS:	1/2" 3/4"
OPENINGS	
EXTERIOR	96" 102"
INTERIOR	102" 108"
CONSULT PRL FOR DETAILS ON CUSTOM 120" TALL DOORS.	

SPECIFICATIONS:

TUBING:	1 1/4" ROUND
MOUNT (THICKNESS)	
GLASS:	1/2" OR 3/4"
RAIL/METAL	1 3/4"

FINISHES:

- STAINLESS STEEL #4 SATIN
- #8 POLISHED
- OTHERS UPON REQUEST

CERTIFICATION:

ANSI/BHMA A156.3-2008 GRADE 1

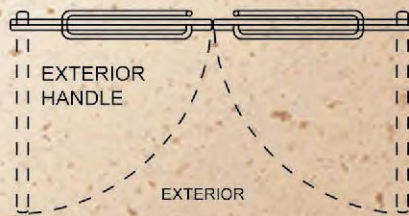
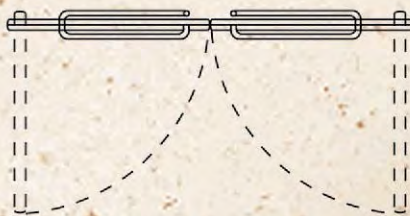

DOOR SWING PROJECTION

*State/local building codes may require top latch for A.D.A. compliance.

**Thresholds are recommended at floor strike applications, floor mounted strikes can be a tripping hazard.

Deadbolts



BP Style Doors/ TVS System



Full Frame Doors/Deadbolt



GLASS MOUNT BRACKET



RAIL MOUNT BRACKET



CYLINDER IN



KEY ACCESS / CYLINDER OUT



FLOOR STRIKE

Panic hardware combined with PRL total Vision System Euro custom fittings are engineered to offer a minimal metal support for door, stabilizer glass fins and Panic hardware/latch strike bracket housing in a single modular unit.

Custom TVS Header

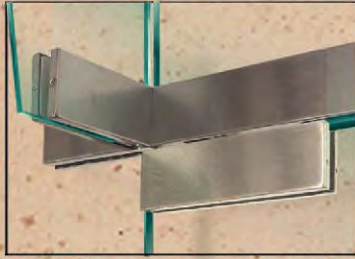

PD-TVS Custom Header
TRANSOM/SL/FIN/PIVOT BRACKET

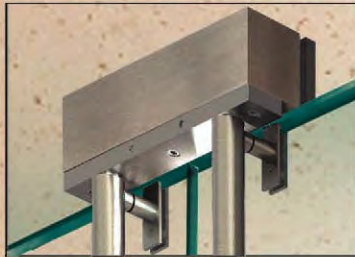

PD- Latch Bracket Assembly
TRANSOM MOUNT



Technical Sales/Support

PRL offers Panic Hardware technical support to complement the product line.

Our technical assistance will save you time and effort coordinating all technical considerations necessary to manufacture functional complete systems.

We can offer drawing details and specifications on entrance systems and related components for your use.

Please contact us for details.

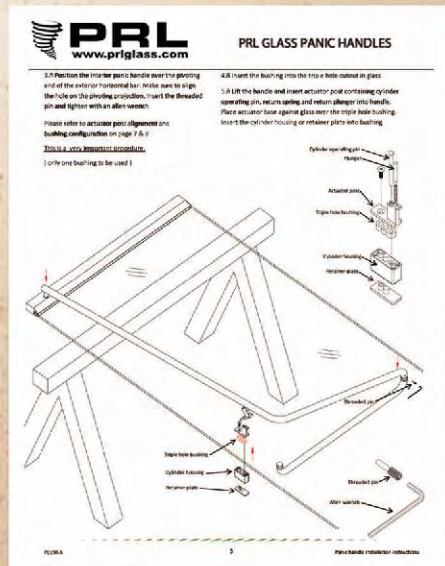



P Style Doors with Custom Easy Lock Pulls & Sandblast Artwork



DB HEAD/STRIKE



BAR END / STANDOFF



DEADBOLT / KEY WAY



THUMBTURN

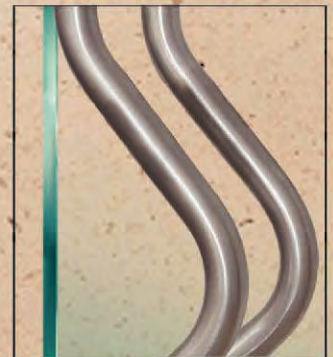

CUSTOM STYLE
(PLEASE CONSULT PRL FOR DETAILS)

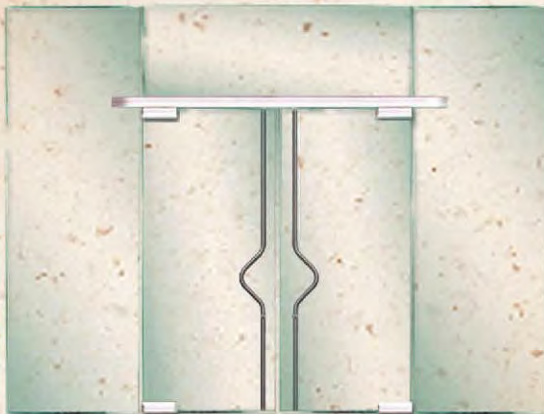

Custom Lock Pulls/TVS System

PRL continues to develop, manufacture and design access/egress hardware for our various door styles.

Custom Lock Pulls are one of many options available.

- Custom Designs
- Locks at Head or Floor.
- Easy locking height (locking mechanism at a convenient height)



Easy Lock Ladder Pulls



Style Doors with Full Height ladder Pull

Custom Upper Bar Lock Pull



PL-LOCK/LADDER

48"(40 3/8") - 60" (44 5/16"),
72" (44 5/16") OAL (CC)



PL-LPLOCK/TT

43 5/16"(48") - 47 1/4"(60-72")
LOCK CL-TT (OAL)

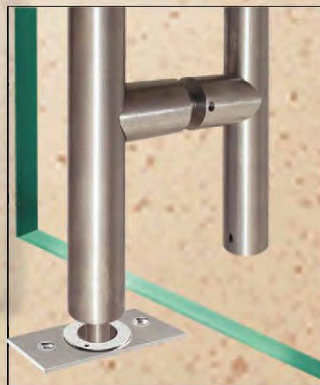

PL-FLOOR STRIKE
1 15/16" X 1 7/16"
DUST PROOF STRIKE OPTION

Easy Lock Ladder Pulls



P Style Doors with EL Ladder Pull



FF Doors with EL short Ladder Pull,
Black Stainless Steel and Cast Glass



Custom A Style Doors with EL short ladder Pull

PRL offers various Egress Control Devices

EZ Touch at the simple act of touching the bar (even through gloves or clothing) activates an electronic sensor which immediately releases the lock.

EZ touch is a convenience Non-Fire Rated Electronic egress Hardware with an innovative Touch Sensitive Technology that integrates to doors with standard or custom exterior pulls.



PRL's innovative EZ Touch Bar system offers,

- Easy Touch Lock Release
- Effortless exit release activation
- Electronically Controlled Safe Magnetic locks
- Low Maintenance Non-Mechanical device
- Adaptable to All Glass, Full Frame & Aluminum Doors
- Various EZ Touch Push/pull styles
- Available in most architectural finishes

EZ-T Hardware shown installed on P Style Doors

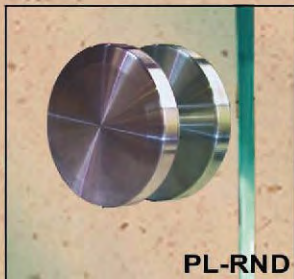

PL-RND
8" DIA.



PL-RCT
10" / 12" CC

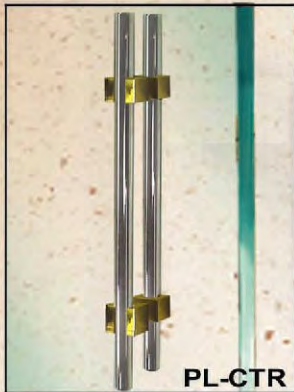

PL-CTR
10" / 12" CC

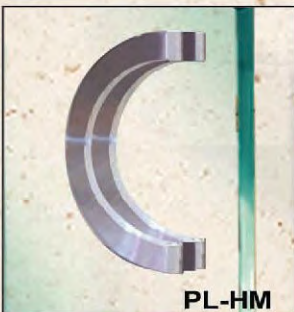

PL-HM
10" / 12" CC



Full Frame Style entrance system with custom pulls in #4 satin stainless steel



PL-VRT
10" / 24" CC

PRL Custom Push/Pulls offer a significant degree of flexibility.

The metal push/pulls are available in several finishes to match or harmonize with most door styles and architectural frames

Dual Tone Series

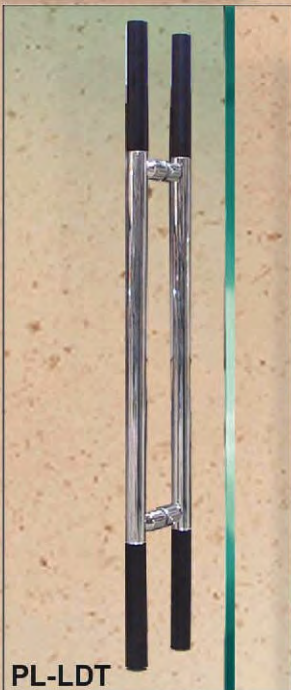

PL-LDT

36"/48" CC



PL-RTDT

4"/24" CC



PL-NDT

24"/24" CC



F Style Glass entrance system with custom DT pulls in pol stainless steel/black anodized

PRL Dual Tone Series Push/Pulls were designed to pair to contemporary style trends.

The DT series push/pulls are available in a dual tone combination and center/end assembly sections in bronze anodized/polished or satin stainless steel

Custom sizes available upon request.



P Style Doors with
Sculptured Style Pulls

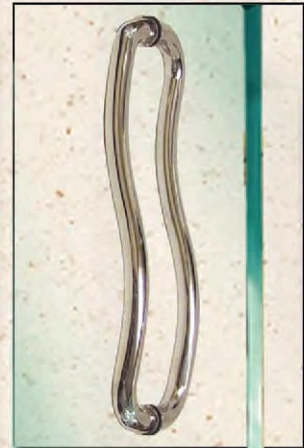

PL-SCULPTURED
16 3/4" CC



Custom Full Frame Doors with SB-Gluechip
artwork and 84" Ladder Style Pulls



PL-DT/LADDER
36"/48"-60"/72"-72"/84" CC/OAL



PL-3
10"/12" CC



PL-3 Offset
10"/12" CC



PL-5
12" CC

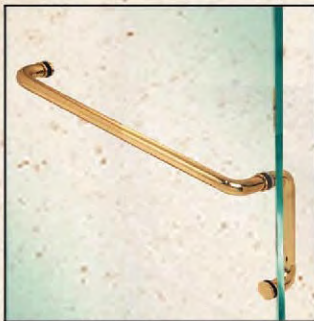

PL-8
10"/28" CC



BP Style entrance system with
PL-3 Pulls in #4 satin stainless steel

PRL Push/Pulls offer a significant degree of flexibility.

The metal push/pulls are available in several finishes to match or harmonize with most door styles and architectural frames

Other Mfr. pulls are also available upon request from Trimco, F & S, Elms & others.

FULL FRAME DOORS

STYLES

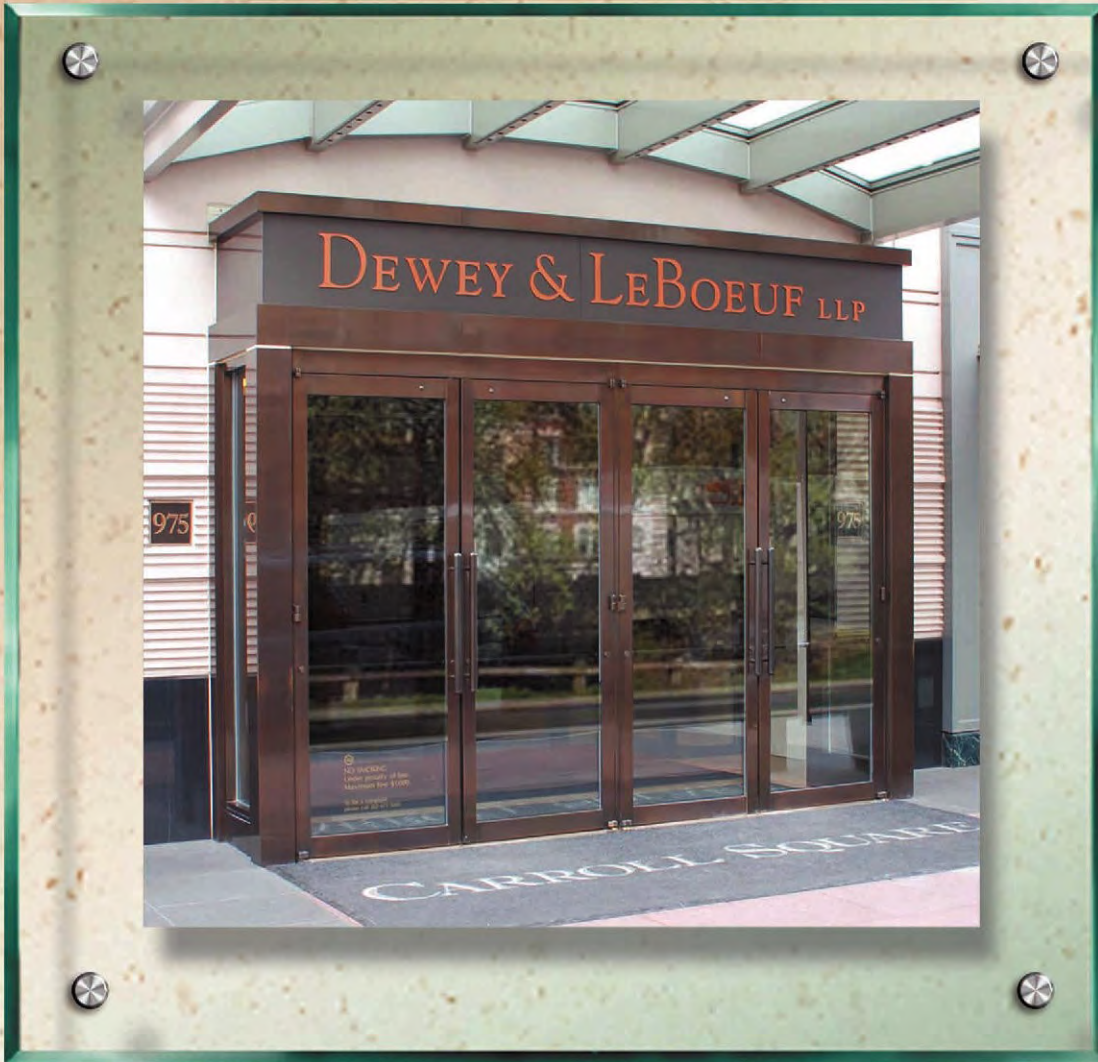

NARROW
3" vertical stile,
4", 5", 10" or
custom height
top/bottom rails



MEDIUM
4" vertical stile,
4", 5", 10" or
custom height
top/bottom rails



CUSTOM
narrow vertical stile, top/bottom
rails, hardware, glass and
sandblast artwork.



MUNTIN
custom intermediate
vertical/horizontal
muntin



STAMPED
Custom Stamped
pattern



WIDE
5 1/2" vertical stile,
5", 10" or
custom height
top/bottom rails

PRL GLASS SYSTEMS

(800) 433-7044

www.prlglass.com



2 1/16" W x 10 1/8" H

PL-1000DS



2 1/16" W x 6" H

PL-600DS



2 1/16" W x 4 1/4" H

PL-350DS



2 1/16" W x 4 1/4" H

PL-150DS



New PL-DSR series are designed to capture 3/8", 1/2" and 3/4" glass and range from 4 1/4" to 10 1/8" in height (custom sizes/modifications are available upon request).

PL-DSR Rails are engineered to accommodate any type of hardware from standard hydraulic swinging door controls, automatic door hardware to mechanical/ electric access controls.

- **Interchangeable faceplates** easy to replace for,
 - damage/scratched material
 - aesthetic changes
 - low cost (face only)
- **Fast door assembly & Easy Adjustment**
 - without door removal



Available in:

- **Aluminum anodized**
clear, dark bronze
- **Clad*, Painted or Custom Finishes**
*stainless/brass pol. or satin

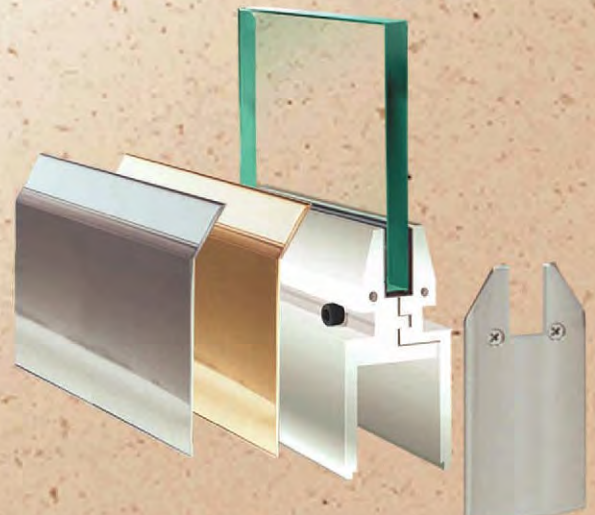

DSR Series rails shown with snap in covers, clad & applied endcap

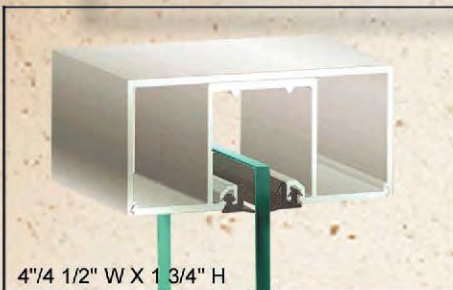

4 1/4" W X 1 3/4" H

PL-HDS

New PL-DS Sidelite and header are designed to capture 3/8", 1/2" and 3/4" glass. Glass is set into PL-Standard rails through a dry glazing method using a epdm compression vinyl for a perfect fit.

DS sidelite range from 4 1/4" to 10 1/8" in height (custom sizes/stacking modifications are available upon request).

DS Header is available in 1 3/4" x 4", 1 3/4" x 4 1/2" and 2" x 4 1/2".



2 1/16" W x 4 1/4" H

PL-150/350DSSL

- 4 1/4", 6 & 10 Std. heights
- Square/Tapered
- Clad Option
- Custom Height

Consult PRL for details.

DSSL Series sidelite rails shown with clad & applied endcaps



DOOR STANDARD FITTINGS



Euro-BP style Doors,
Transom & SL System



PL-450

TRANSOM/SL/FIN/PIVOT BRACKET
4 1/8"H / 8 1/2" W



PL-440

TRANSOM/ SL/ PIVOT BRACKET
4 1/8"H / 8 1/2" W



PL-414/424

BOTTOM / TOP PATCH FITTING
2"H / 6 1/2" W



PL-16500

LOCK PATCH FITTING
2"H / 6 1/2" W

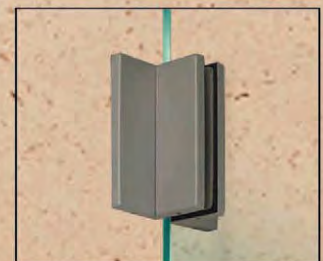

PL-467

SM(SIDE/TOP) FIN BRACKET
4 3/8"H / 4 5/8" W

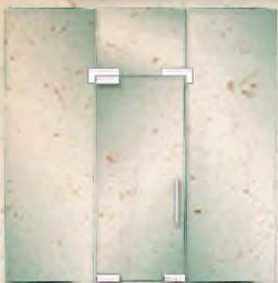

TOTAL VISION SYSTEMS
BASIC CONFIGURATIONS

* State/local building codes may
require doors bottom full rail.

PRL **Total Vision System** takes glass to a full magnitude with an absolute transparency, with Euro fittings that are a minimal metal door support offered in a combined modular dimension and engineered to accommodate door hardware.

Fittings use a dry/mechanical glazing method with precision bolt in a versatile modular dimension (2" x 6/12"). Features removable coverplates with available finishes in aluminum anodized, Stainless steel and brass (brushed/polished).

**Custom modifications
available upon request***
*some limitations may apply

PRL GLASS
SYSTEMS

(800) 433-7044

www.prlglass.com

Security access controls



A Door/Sidelite with DSG euro lock fitting

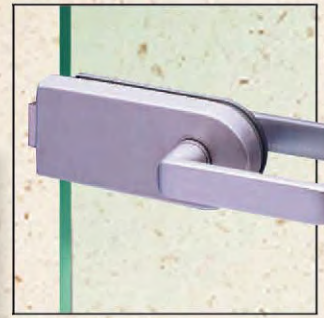

PL-DSR
2 9/16"H /
6 1/4" W



PL-DSC
2 9/16"H /
6 1/2" W



PL-DSG
2 15/16"H /
6 7/8" W



PL-DSS
2 9/16"H /
8 1/4" W



Custom Doors with custom centerlock/strike housing and Latchlock .



Custom Gate with custom centerlock/strike housing and Latchlock .

Any type of locking specialty hardware can also be accommodated such as,

- Latch locks/lever handles
- Electric/Mechanical access devices



8" Pull / long throw deadlock

PL-CLH1

10"H / 6" W



Deadlatch lock/ lever handles
Strike Housing available

PL-CLH2

10"H / 6" W

PRL GLASS SYSTEMS

(800) 433-7044

www.prlglass.com

ENTRANCE SLIDER SYSTEMS



Tiffany
All Glass Top Hung Slider



Clearvision
Movable Glass Wall



Max' Alumunim Sliders

- Top Hung/Bottom Roller
- Angular & inline Configurations



Ruby Series
All Glass Top Hung Slider System

All Glass Doors and Sliding system are elegant and frameless. Sliding systems the perfect solution for conditions with space limitations.

PRL All Glass Doors provide the best in strength and design, creating a unique and modern look for residential or commercial applications. These systems enhance the appearance of a room with the transparency between areas, making a room appear larger and open.

GUARDRAILS/HANDRAILS



Flex
HR Post/Glass Clamps

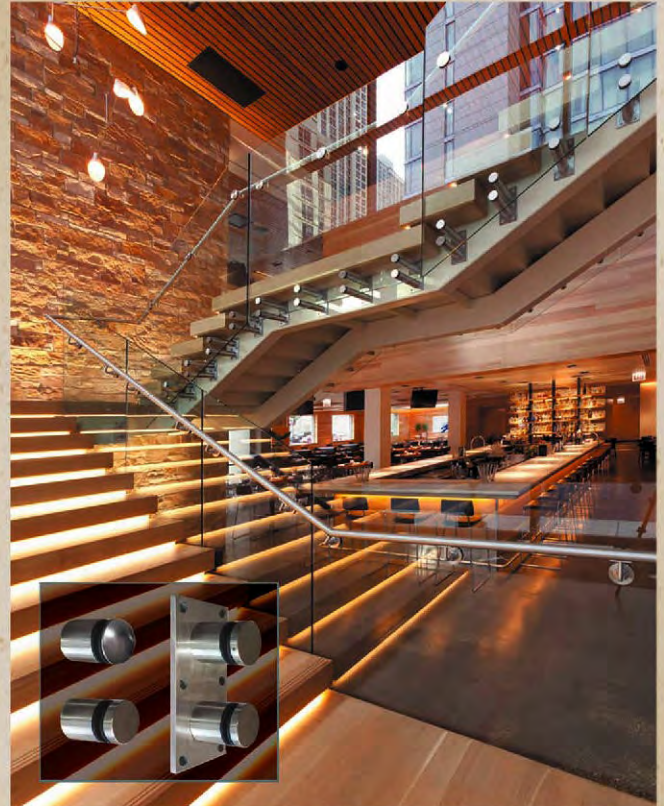

Elegante
Stand-Off Surface Mount



Infinity Floor Post Mount
Aluminum Modular Railing

Rapid
Dry-Set



PRL offers complete handrails and guardrails systems for 1/2" or 3/4" glazing. We manufacture and extrude all components in house.

PRL's Railing Systems brings new innovation to the Architectural and design industry. These systems are in demand due to their frameless features. Most systems use tempered or laminated glass.

PRL GLASS SYSTEMS

All systems are fabricated and prepared to make installation easier.

(800) 433-7044

www.prlglass.com

SHOWER / STEAM UNITS



Nu-Vision Shower Doors have many different configurations from the basic single door to the most complex custom shower steam unit design.

PRL's shower door units are fabricated to exact size, selected thickness and configuration to fit your opening and finished to match the dwelling décor. The frameless shower enclosures and steam units will give bathrooms a distinctive look. The all glass frameless units enhances the beauty of bathrooms tile or marble work. Nu-Vision Frameless Shower door units feature tempered safety glass in every application.

PRL GLASS
SYSTEMS

(800) 433-7044

www.prlglass.com

GLASS

Glass Selection



Full Frame Doors w/Custom Laminated Glass



IG UNITS



STARPHIRE/
CLEAR



CUSTOM
Gluechip/Sandblast



TEXTURED
Designer Patterns



BLUE
GREEN



AZURIA



BRONZE/
GRAY



CAST



LAMINATED
Custom Makeups



PRL offers a wide variety of glass types that range from high visibility to obscured designer textured patterns. Available thicknesses are 3/8" on framed systems, 1/2" and 3/4" on frameless systems. Please consult us for details.

(800) 433-7044

www.prlglass.com

Access Controls



ELECTRIC LOCKS/STRIKES



HINGES/PIVOTS



FLOOR/OHCC CLOSERS

PRL offers standard and specialty hardware as integral or accessory component on all our product lines,

Latch locks/lever handles

Access Controls

- Electric Strikes
- Electromagnetic Locks

Electric/Mechanical access devices

Door controls

- Floor or OHCC closers
- Top/Bottom Pivots
- Butt Hinges



Curtainwall



Doors/Storefront



Gates

PRL's Aluminum Storefront systems are designed for Commercial and Residential applications. Our goal is to offer you a complete storefront system that includes glass, entrance doors and hardware.

The Curtainwall and storefront aluminum systems performance is excellent for air/water infiltration, gust wind loads, seismic design and hurricane impact resistance.

PRL technical assistance will save you time and effort coordinating the concept, design, material selection and evaluation of technical considerations necessary to manufacture functional complete systems with all related mechanical devices and ensure full compliance to specifications.



...from single custom openings

PRL uses the latest CAD/CAM to produce shop drawings, layouts, details and specifications on entrance systems.

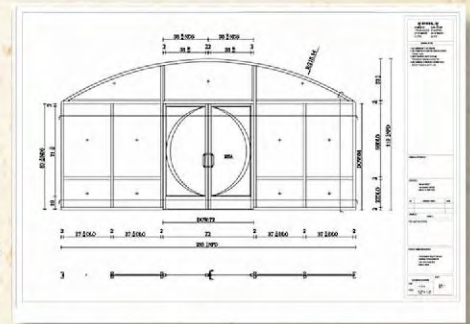

to large projects...

ALUMINUM DOORS

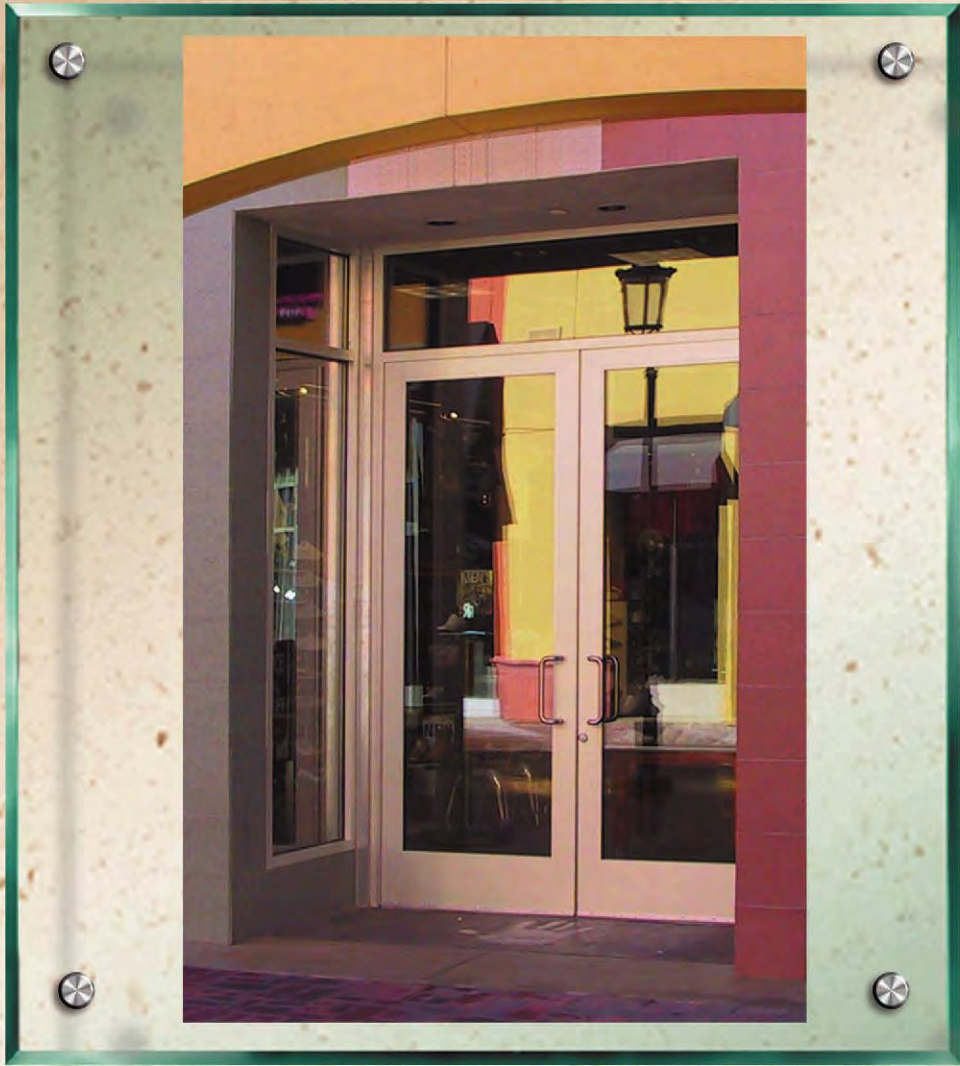

STYLES



NARROW
2" vertical stile,
2", 3 1/4", 5 1/8", 10"
or custom height
top/bottom rails



MEDIUM
3 1/2" vertical stile,
3 1/4", 5 1/8", 10"
or custom height
top/bottom rails



WIDE
5" vertical stile,
5 1/8", 10" or
custom height
top/bottom rails



OVERSIZE
Reinforced frame

Aluminum Entrance Doors are available in single acting offset pivot, butt hinge or center pivot operation. High bottom rails may be adapted to all sizes and to meet local codes. All doors are produced to specific size requirements in widths and heights within limits of each specific door.

Narrow, Medium & Wide stiles are the industry standard, All of them offer strong reinforced corner construction for top performance and permits their use in heavy traffic areas of commercial applications.



CUSTOM
Any vertical stile,
top/bottom rail
& intermediate vertical/
horizontal muntins.

GLASS

TINTED UNCOATED



Provides excellent solar control with a versatile range of tints. Offers high levels of natural daylight while lowering solar heat loads.

- Evergreen/Atlantica*
- Super Gray*
- Green 2000*
- Pacifica*
- Gray*
- Solarblue*
- Solexia/Green*
- Blue Green*

*colors not shown

Product companion,

400 SERIES
1 3/4" x 4"
1/4" CENTER GLAZED

450 SERIES
1 3/4" x 4 1/2"
1/4" CENTER GLAZED



Azuria



Gray



Bronze

REFLECTIVE



A pyrolytically-coated glass for improved solar control. That also offers UV rays protection and blocks solar heat.

- Solarcool*
Solarblue
- Vistacool*
Pacifica
- Solarcool Pacifica*
- Solarcool Bronze*
- Green RC*
- Bluegreen
Eclipse Advantage
LOW_E*
- Green 2000T*

*colors not shown

Product companion,

400 SERIES
1 3/4" x 4"
1/4" CENTER GLAZED

450 SERIES
1 3/4" x 4 1/2"
1/4" CENTER GLAZED

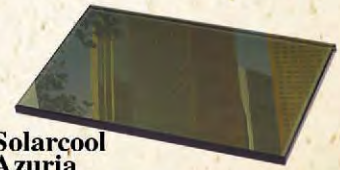

Solarcool
Azuria



Solarcool
Gray

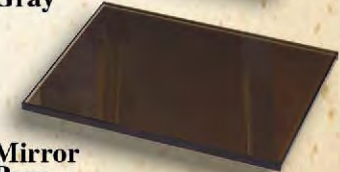

Mirror
Pane

TEXTURED GLASS

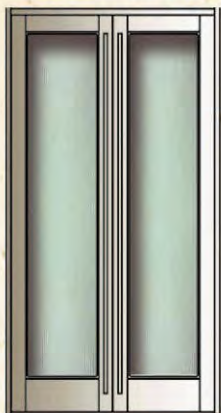

Distinct Entrances/Storefronts will require discrete privacy, texture glass is the perfect solution.

- Bamboo Frost*
- Clear Flemish*
- Clear Delta*
- Crossreed*
- Wire-Obscure
- Delta Frost*
- P-516*
- Bronze*
Gluechip

*colors not shown



Reeded

I.G. UNITS

A high quality, total energy performance product

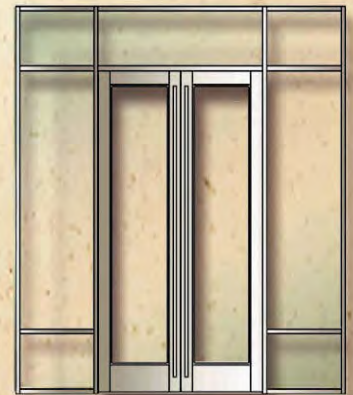

Product companion,

250 SERIES
2" x 4 1/2"
1" CENTER GLAZED

Note: Samples shown are for illustration purposes only, colors may vary from actual samples. Performance data is available upon request. Please consult PRL for details and availability.

Note: Samples shown are for illustration purposes only, color/designs may vary from actual samples. Please consult PRL for details and availability.

Euro-MasterGlass Series



5/16" MASTER-RAY



3/8" MASTER-CARRE



5/16" MASTER-POINT



5/16" MASTER-LENS



5/16" MASTER-LIGNE



3/8", 1/2"
SANDBLASTED



3/8", 1/2"
ACID ETCH/MATTE



3/8", 1/2"
GLUECHIP



3/8", 1/2"
DOUBLE GLUECHIP



3/8", 1/2"
OCEANIC GLUECHIP



3/8" RAINYVIEW



3/8" VANIA



3/8" THELA



3/8" LISTRAL



CUSTOM GLUECHIP/
SB DESIGN

Low-Iron Krystal Glass Series



3/8" KRYSTAL STORM



3/8" KRYSTAL
SERENITY



3/8" KRYSTAL
GLACIER



3/8" KRYSTAL
RAIN



3/8" KRYSTAL
FLUTEX

Accordion Bifold System



- Aluminum Multiple Panels
- In-line
- Dual function slide/bifold
- Weather Resistant

PRL new Accordion Sliding Bifold Door System is designed with multiple architectural features. These doors are built of aluminum and glazed with tempered glass 1" IG units that make them durable, strong, and long lasting.

The great advantage of bifold sliding doors is that they can be stacked, creating a completely unobstructed opening.

PRL GLASS SYSTEMS

(800) 433-7044

www.prlglass.com



GLASS SYSTEMS
www.prlglass.com

Aluminum
ARCHITECTURAL PRODUCTS
www.prlaluminum.com

PRL GLASS SYSTEMS
13644 NELSON AVE.
CITY OF INDUSTRY, CA. 91746

Newest One Stop Shop Laminated Glass Applications

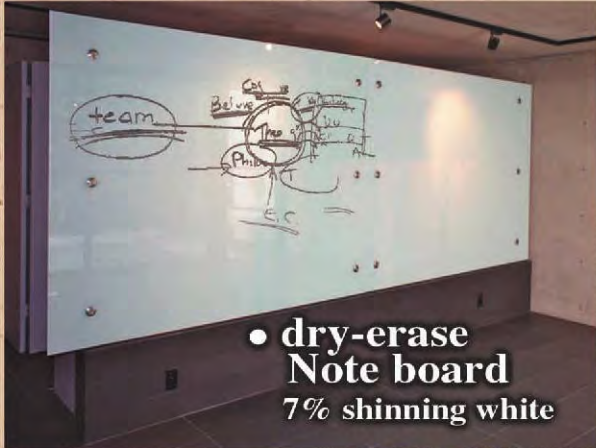

- **dry-erase Note board**
7% shining white



- **Countertops**
3/4" / .060 clear / 3/4" = 1 1/2"



- **Bullet resistant**
1" thickness / lighter alternative



- **Guardrails**
SentryGlass / stronger railing

- **Custom Lami**
Compound Surface Panels

New!

**Quick,
Quote & Order
LAMI Online!**
www.prlglass.com



Privacy Glass
available



- **Doors**
65% sand white

**No Delays
24/7**

for estimates & orders,
Call (877) 775 2586 fx (877) 274 8800