

Complete

ARCHITECTURAL GLASS & METAL

Custom fabrication with **expert**
CRAFTSMANSHIP



| | Page |
|--------------------------------------|------|
| ● PRL Panic Devices | 1 |
| ● All Glass Doors | 6 |
| ● Pulls | 13 |
| ● ED Hardware | 18 |
| ● Fix-Point Systems | 24 |
| ● Sandblasting | 25 |
| ● Sliding Doors/ Stacking Systems | 28 |
| ● Specialty Hardware | 36 |
| ● Full Frame Doors | 38 |
| ● Architectural Metals | 40 |
| ● Aluminum Doors | 42 |
| ● Storefronts/ Curtainwall | 50 |
| ● Architectural Glass | 52 |
| ● Guardrail/Handrails | 54 |
| ● Shower Units | 62 |



PRL

GLASS
SYSTEMS
www.prlglass.com

Aluminum
ARCHITECTURAL PRODUCTS
www.prlaluminum.com

One Stop Shop

with the *fastest* leadtimes* in the industry, guaranteed!

Panic Devices/Egress controls

Revolutionary
& Adaptable
Panic Hardware
that changes
traditional
ageless design

- *Innovative*
- *Custom Design*
- *Options*



Round Bar/
Mitered Corners

PRL GLASS SYSTEMS

Custom
Square
Bar



Features,

- Standard & Custom Configurations/
Exterior Handles
- Dummy Handles
& Deadbolt
- Secure Cylinder/
Key Housing
- All Glass, Full Rail
& Custom Mounting
- Door stop/
Strike bracket
- Custom Finishes
Available*
- Electric Strike
Controls

Easier
MAINTENANCE

- **PRL** Panic bar
protective coating*

*consult PRL for details



Panic Devices/Egress controls



A Style Door with Panic Device and exterior key access/custom handle.



A Style Door with PL100 Panic Device/ D exterior handle



BP Style Door with PL100 Panic Device/ B exterior handle



P Style Door w/ PL100 Panic Device/ A exterior handle



FF Style Door w/ PL100 Panic Device/ A exterior handle

PRL manufactures PL-100 series panic device. This panic is a contemporary design offered primarily for all glass door entrance systems. The slim 1 1/4" dia. interior bar conceals the latching mechanism allowing minimal uninterrupted view on 1/2" or 3/4" glass. With the strict american with disabilities (A.D.A.) code this makes the PL-100 the right choice for installers. PRL panics have been tested in accordance to the american national standard for exit devices, ANSI/BHMA A 156.3-2008, Grade 1 certified and UL305, standard safety for panic devices.

PL-100 devices can also be dogged by sliding a pin located below the cylinder housing which allows the panic to remain in an open position giving free access during business hours. An electric strike can also be utilized with this device to work in conjunction with a remote keyless application.

Available finishes:

- Polished or Satin Stainless Steel
- Oil rubbed bronze
- Polished or Satin Brass
- Powder Coat Paint

Panics can be manufactured to be installed on wood and aluminum doors, please consult factory.

Fittings



BP Style Doors/ TVS System



1- STRIKE BRACKET



2- GLASS MOUNT BRACKET



3- RAIL MOUNT BRACKET



4- PD SUPPORT BRACKET



5- LOCK HOUSING

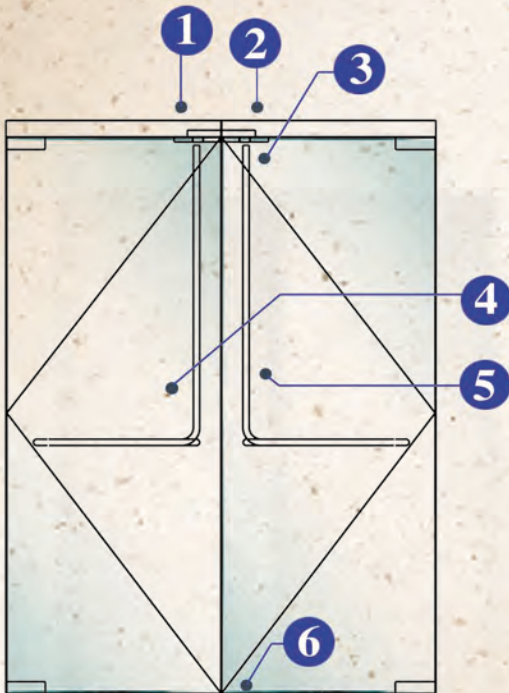

PRL Panic Devices minimal tubular housing accommodate over 100 precision manufactured components engineered and mechanically synchronized for a safe panic function.

Various modular Fittings are offered as separate options to make panic applications versatile. Range from mechanical strikes to remotely operated access/egress electric controls.

Custom modifications available upon request*

*some limitations may apply



6b- T-HOLD STRIKE (PL 110 ONLY)



6- FLOOR STRIKE (PL 110 ONLY)

* State/local building codes may require doors bottom full rail.

Panic Device Exterior Handles

PRL Panic Devices exterior handles are available in All Industry standard styles from A to Y.

Most popular styles are shown, to view our full line visit prlglass.com



BP Style Door with PL-100 Panic Device/ standard A exterior handle

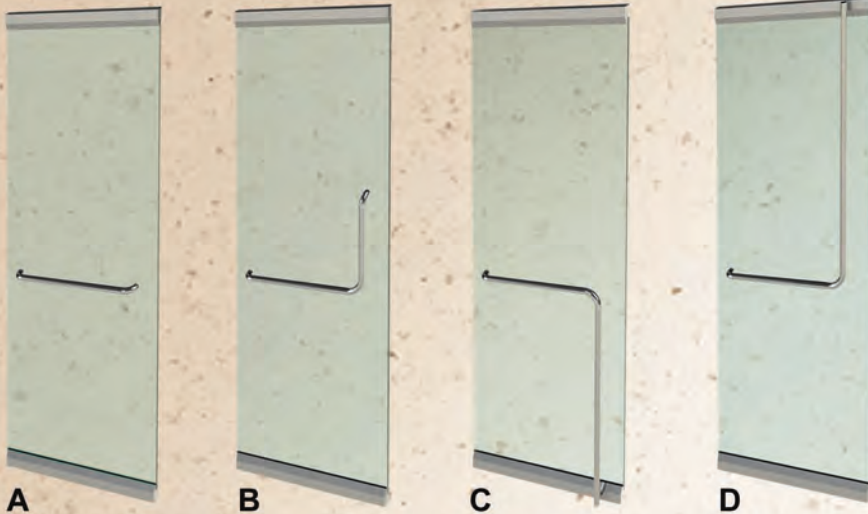

P Style Door with PL100 Panic Device, exterior key access and custom exterior Pull.

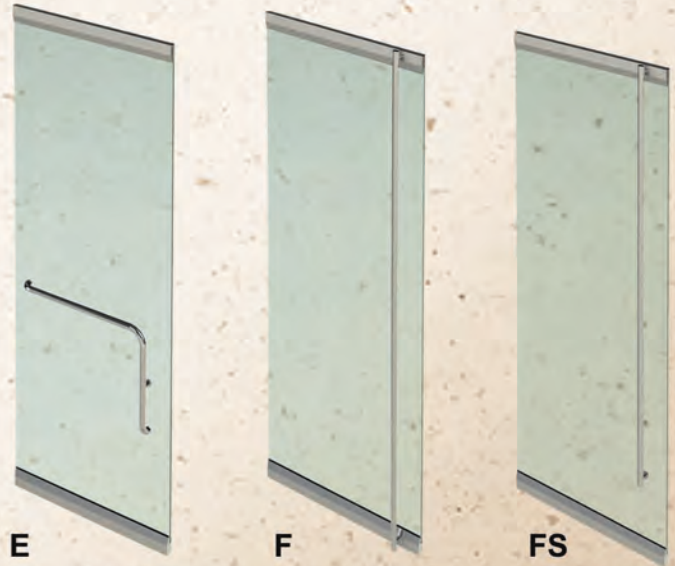

● **PRL Advantage,**
We go beyond offering Custom Exterior Pulls that significantly increases Design adaptability with an unlimited range of combinations.

Available metal finishes are stainless steel (satin or polished) and custom finishes upon request. Consult us for details.

Panic Device Configuration/ Specifications

PRL manufactures two types of panic devices PL-100 for top latch and PL-110 for floor latch application.

- Exterior handles
Std. Styles/Custom
- Lock Options
Cylinder/Lock housing,
mechanical/electric strikes
- Mount type hardware
Glass/Metal
- Door applications
All glass, Full frame Glass,
Storefront aluminum & wood

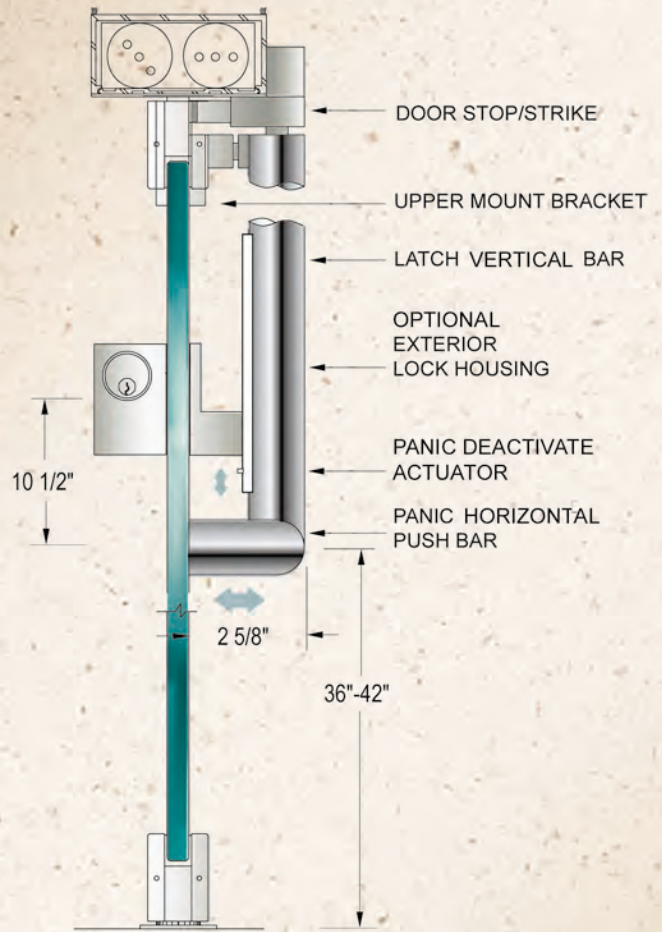

PL SERIES PANIC HANDLE GLASS MOUNT SHOWN

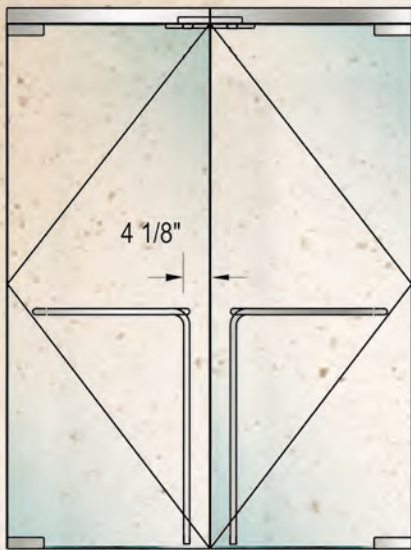

PL-110

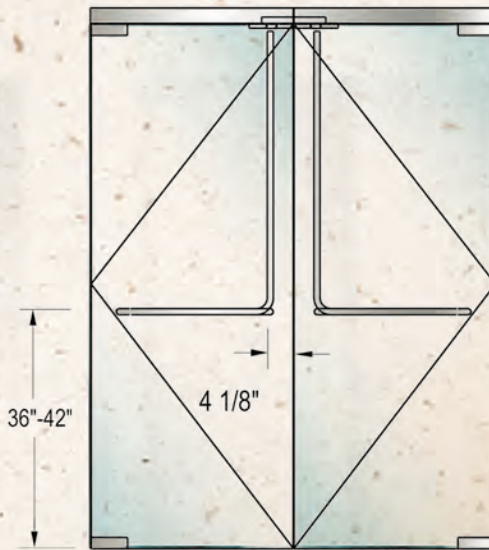

PL-100

| | |
|--------------------------------|-------------------------|
| RECOMMENDED DOOR SIZES: | |
| GLASS THICKNESS: | 1/2" 3/4" |
| OPENINGS | |
| EXTERIOR | 96" 102" |
| INTERIOR | 102" 108" |
| SPECIFICATIONS: | |
| TUBING: | 1 1/4" ROUND |
| MOUNT (THICKNESS) | |
| GLASS: | 1/2" OR 3/4" |
| RAIL/METAL | 1 3/4" |
| FINISHES: | |
| STAINLESS STEEL | #4 SATIN #8 POLISHED |
| OTHERS UPON REQUEST | |

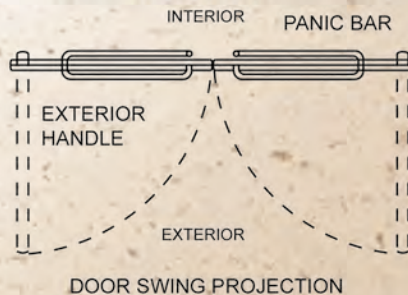
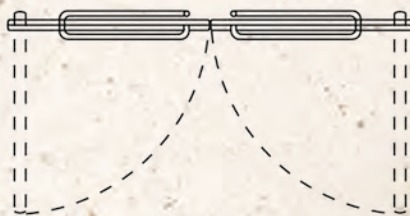

*State/local building codes may require top latch for A.D.A. compliance.

**Thresholds are recommended at floor strike applications, floor mounted strikes can be a tripping hazard.

Panic hardware combined with PRL total Vision System Euro custom fittings engineered to offer a minimal metal support for door, stabilizer glass fins and Panic hardware/latch strike bracket housing in a single modular unit.

Custom TVS Header

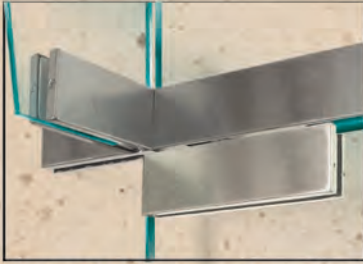

PD-TVS Custom Header
TRANSOM/SL/FIN/PIVOT BRACKET
4 1/8" H / 8 1/2" W



Technical Sales/Support

PRL offers Panic Hardware technical support to complement the product line.

Backed with the best workmanship and Panic hardware material quality as in any of PRL complete Tempered glass entrance Systems

PRL technical assistance will save you time and effort coordinating the concept, design, material selection and evaluation of technical considerations necessary to manufacture functional complete systems with all related mechanical devices and ensure full compliance to specifications.

PRL can offer drawing details and specifications on entrance systems and related components for your use.

Please contact us for details.

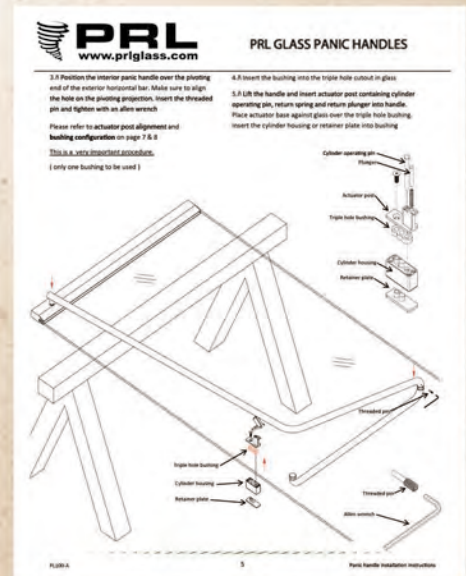



WS450

1 3/16" narrow vertical stile, continuous top and bottom rails from any square shape PL-Series rails.



P

Continuous horizontal top and bottom rails from any PL-Series rails.



BP

Corner patch rail in a 9 1/2" from any PL-Series rails or PL-Euro series fittings, continuous horizontal bottom rail from any PL-Series rails.



F

Corner patch rails at pivot and lock points in a 9 1/2" section from any PL-Series rails or PL-Euro series fittings.



A

Corner patch rails at pivot points (no lock patch) in a 9 1/2" section from any PL-Series rails or PL-Euro series fittings.



PRL Heavy glass doors are available in various standard styles and are offered with continuous rails or corner patch rails combinations. Available metal finishes are stainless steel, brass (satin or polished), anodized aluminum and powder coat paint.



Custom Height P Style doors
with ladder pulls

PRL Nu-Vision Entrance Doors are fabricated to your particular configuration. All we need is your dimensions and we will take care of the rest.

- In house production capabilities,
- Technical design & Lay out dept.
 - Alum. Extrusion Press (extrusions)
 - Architectural Hardware
 - Glass Fabrication (tempering)
 - Architectural metals dept. (breakformed cladding)
 - Sandblasting and Artwork dept. (corporate logos)

This forms PRL into a **one stop shop.**

Complete ENTRANCE SYSTEMS

• Single Entrance Doors

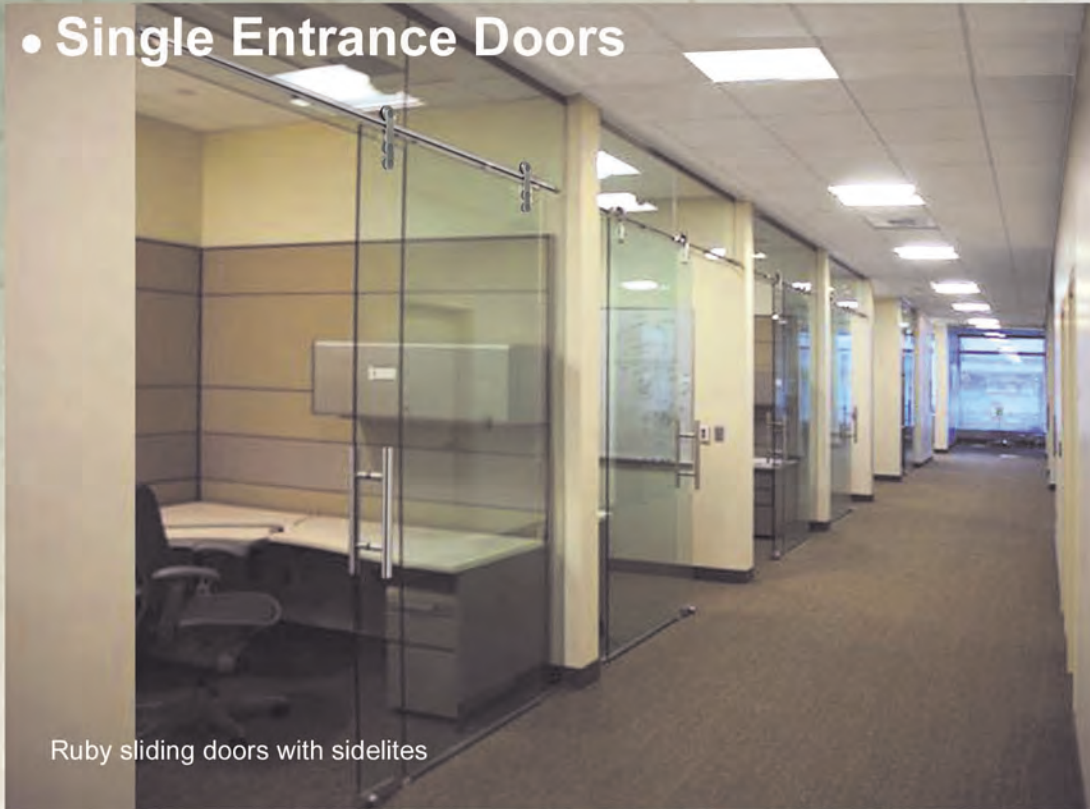

Ruby sliding doors with sidelites



Tiffany sliding doors with sidelites



• Complex large-scale systems...



PL-1000DS



PL-600DS



PL-350DS



PL-150DS



New PL-DSR series are designed to capture 3/8", 1/2" and 3/4" glass and range from 4 1/4" to 10 1/8" in height (custom sizes/modifications are available upon request).

PL-DSR Rails are engineered to accommodate any type of hardware from standard hydraulic swinging door controls, balanced door hardware, automatic door hardware to mechanical/ electric access controls.

- **Interchangeable faceplates** easy to replace for,
 - damage/scratched material
 - aesthetic changes
 - low cost (face only)
- **Fast door assembly & Easy Adjustment**
 - without door removal



Available in:

- **Aluminum anodized**
clear, dark bronze
- **Clad*, Painted or Custom Finishes**
*stainless/brass pol. or satin

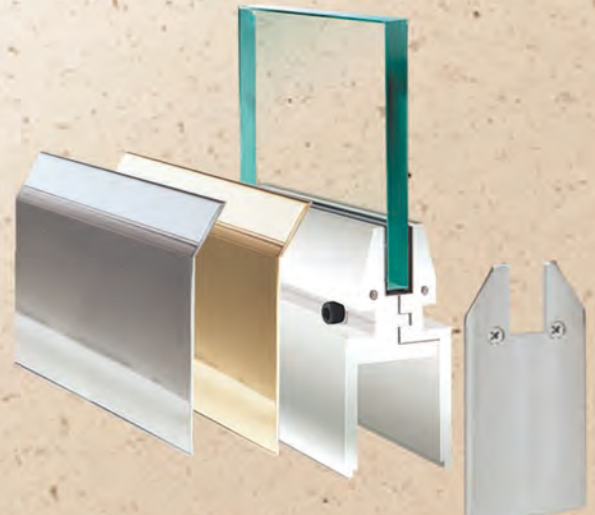

DSR Series rails shown with snap in covers, clad & applied endcap

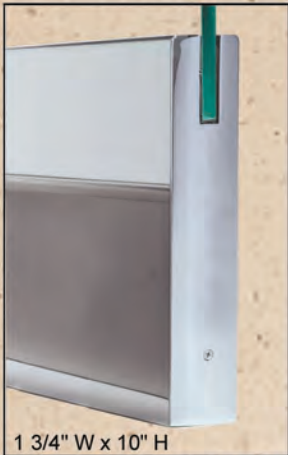

1 3/4" W x 10" H

PL-1000



1 3/4" W x 6" H

PL-600



1 3/4" W x 3 5/16/3 7/8" H

PL-350/387



1 3/4" W x 3 5/16" H

PL-150



PL-Elegance rails are set through a wet glazing method using a high-strength controlled compression cement to create a one piece perfect bond.

Sizes on PL-Standard rails range from 3 5/16" to 10" in height (custom sizes/modifications are available upon request).

- One Piece Rail / Welded Endcap
- High-Strength wet glazing compression cement assembly
- High luster/ metal finishes
- Machine radius ends w/welded endcaps
- Adjustment access Segmented cover



PL Series rails shown in stainless steel clad

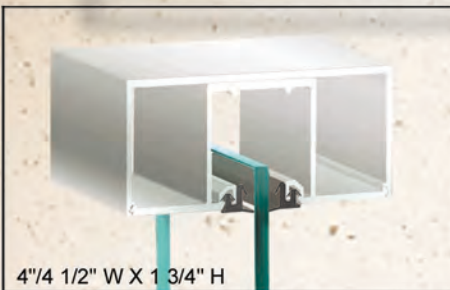

4" 1/2" W X 1 3/4" H

PL-HDS

New PL-DS Sidelite and header are designed to capture 3/8", 1/2" and 3/4" glass. Glass is set into PL-Standard rails through a dry glazing method using a epdm compression vinyl for a perfect fit.

DS sidelite range from 4 1/4" to 10 1/8" in height (custom sizes/stacking modifications are available upon request).

DS Header is available in 1 3/4" x 4" and 1 3/4" x 4 1/2".



2 1/16" W x 4 1/4" H

PL-150/350DSSL

- 4", 6 & 10 Std. heights
- Square/Tapered
- Clad Option
- Custom Height

Consult PRL for details.

DSSL Series sidelite rails shown with clad & applied endcaps





PL-3
10"/12" CC



PL-3 Offset
10"/12" CC



PL-5
10"/12" CC

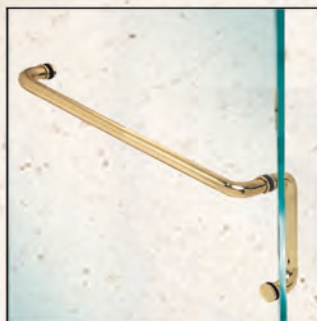

PL-8
10"/28" CC



BP Style entrance system with
PL-3 Pulls in #4 satin stainless steel

PRL Push/Pulls offer a significant degree of flexibility.

The metal push/pulls are available in several finishes to match or harmonize with most door styles and architectural frames

Other Mfr. pulls are also available upon request from Trimco, F & S, Elms & others.

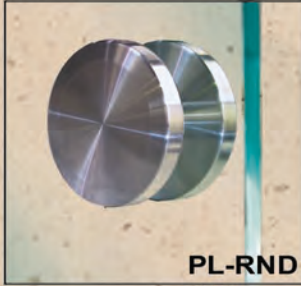

PL-RND
8" DIA.



PL-RCT
10" / 12" CC



PL-CTR
10" / 12" CC



PL-HM
10" / 12" CC



Full Frame Style entrance system with custom pulls in #4 satin stainless steel and Custom Cast Glass



PL-VRT
10" / 24" CC

PRL Custom Push/Pulls offer a significant degree of flexibility.

The metal push/pulls are available in several finishes to match or harmonize with most door styles and architectural frames



PL-LDT
36"/48" CC



PL-RTDT
4"/24" CC

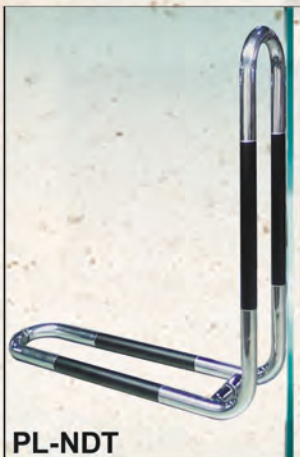

PL-NDT
24"/24" CC



F Style Glass entrance system with custom DT pulls in pol stainless steel/black anodized

PRL Dual Tone Series Push/Pulls were designed to pair to contemporary style trends.

The DT series push/pulls are available in a dual tone combination and center/end assembly sections in bronze anodized/polished or satin stainless steel

Custom sizes available upon request.

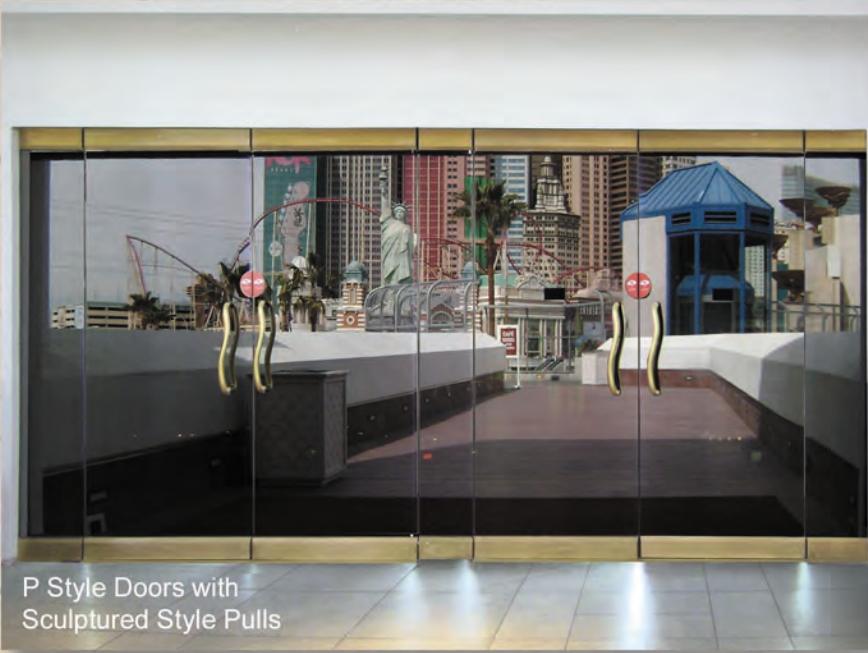

P Style Doors with
Sculptured Style Pulls



PL-SCULPTURED

16 3/4" CC



Custom Full Frame Doors with SB-Gluechip
artwork and 84" Ladder Style Pulls



PL-DT/LADDER

36"/48"-60"/72"-72"/84" CC/OAL

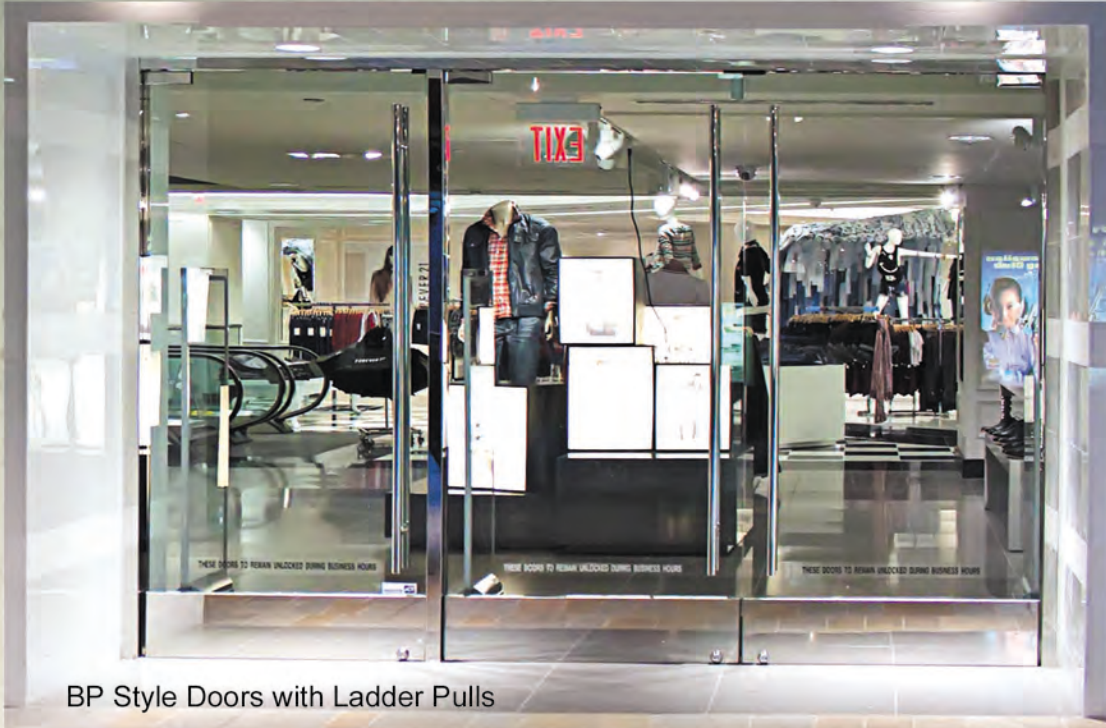

BP Style Doors with Ladder Pulls



BP Style Doors with custom Pulls, Sandblast & Fixed Panels System

Simple, technically intricate and still elegant concepts through PRL's expert craftsmanship, become luxurious and functional Entrance systems.

DOOR STANDARD FITTINGS



Euro-BP style Doors,
Transom & SL System



PL-450
TRANSOM/SL/FIN/PIVOT BRACKET
4 1/8"H / 8 1/2" W



PL-440
TRANSOM/ SL/ PIVOT BRACKET
4 1/8"H / 8 1/2" W



PL-414/424
BOTTOM / TOP PATCH FITTING
2"H / 6 1/2" W



PL-16500
LOCK PATCH FITTING
2"H / 6 1/2" W



PL-467
SM(SIDE/TOP) FIN BRACKET
4 3/8"H / 4 5/8" W



TOTAL VISION SYSTEMS
BASIC CONFIGURATIONS

* State/local building codes may require doors bottom full rail.

PRL **Total Vision System** takes glass to a full magnitude with an absolute transparency, with Euro fittings that are a minimal metal door support offered in a combined modular dimension and engineered to accommodate door hardware.

Fittings use a dry/mechanical glazing method with precision bolt in a versatile modular dimension (2" x 6/12") . Features removable coverplates with available finishes in aluminum anodized, Stainless steel and brass (brushed/polished).

Custom modifications available upon request*
*some limitations may apply

PRL GLASS SYSTEMS

(800) 433-7044

www.prlglass.com

Security access controls



A Door/Sidelite with 19102 euro lock fitting and 1910 lever handle.



Euro latch lock/
Lever 1012

PL-18102

3 1/8"H /
5 1/2" W



Latch/strike housing
*1900 series also available

PL-18100

3 1/8"H /
5 1/2" W



Euro latch lock/
Lever 1910

PL-19102

3 1/8"H /
6 3/4" W



Horizontal/Vertical
Throw bolt lock

PL-16300

4 1/4"H / 3" W



Custom Doors with Centerlock/Strike housing



BP Doors with Centerlock/Strike housing

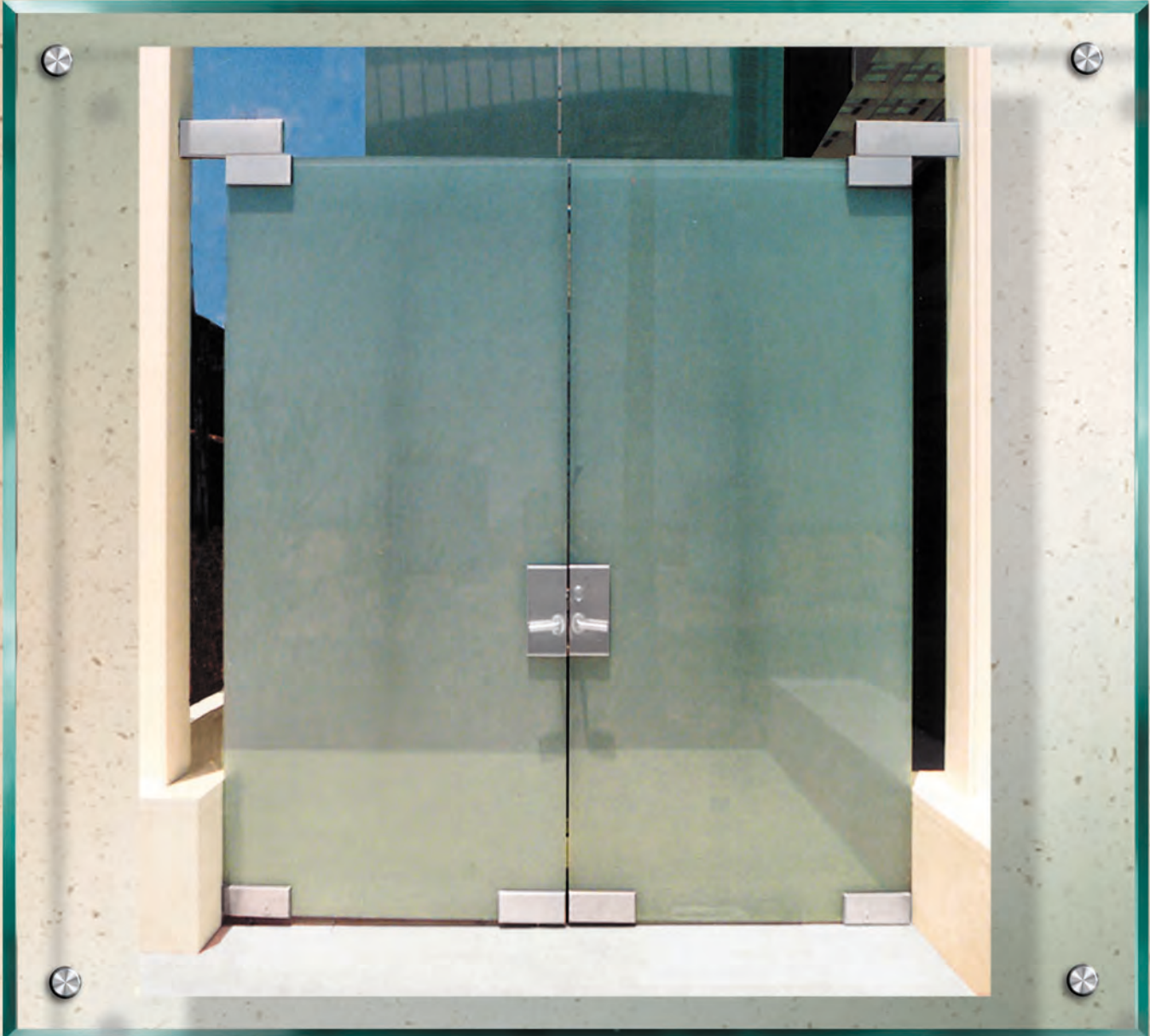

F Doors with custom centerlock/strike housing, Latchlock and electric strike.

Any type of locking specialty hardware can also be accommodated such as,

- Latch locks/lever handles
- Electric/Mechanical access devices



8" Pull / long throw deadlock

PL-CLH1
10"H / 6" W



Deadlatch lock/ lever handles
Strike Housing available

PL-CLH2
10"H / 6" W



full frame door
w/powder coat & masterligne glass



Closet doors w/ 3/8" Acid etched glass



Closet Doors w/3/8" Spandrel glass



Service Door w/Acid etched glass



F Style door with PL-16500 lock fitting



Euro Style door with Masterlens



BP Style door with acid etch glass



A Style door with rainy view glass

In some instances designers will require to gradually obscure glass transparency. In these conditions textured glass or custom textured glass becomes a perfect solution.



PRL offers a flexible and functional glass fixed point mount system (spiders) which is extremely versatile with a modular combination of fittings to accommodate almost any project requirement.

The increasingly project complexity utilizes minimal mechanical metal fittings and transparency of glass to integrate building spaces with nature. Applications are diverse include exterior and interiors.



PL-SPDR

SPIDER FITTING
7 7/8" H/W CC

Consult PRL for system horz/vert span limitations.



SANDBLASTING

PRL Designer/Artists are available to assist you with your design work through an extensive computer and hand-drawn graphics/images files.

Elaborate design concepts can be accomplished in coordination with Architects/Designers CAD drawings/graphics (standard formats).



Ruby All Glass Sliding system
glass/wall offset mount

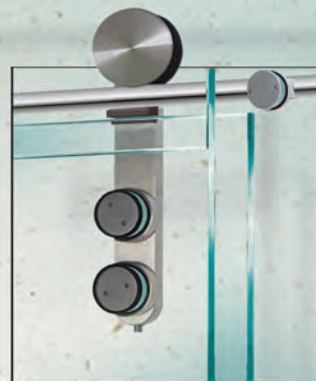

Glass Mount

PL- HDSRBS
SLIDING ROLLER



Wall offset
surface mount

PL- LSTOPBS
ROLLER STOP



Ruby All Glass Sliding system glass/wall offset mount



Top Hung Ruby Slider System



Pivot Ruby System

- Single/Multiple Panels
- In-line/Angular
- Frameless panels
- Point hanger/roller system
- Point Bottom Guide/Pin
- Point lock



PL-TPS

BAR WALL MOUNT BRACKET
1 3/4" DIA

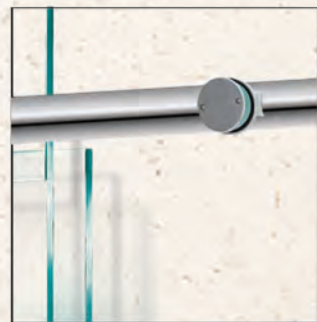

PL-RCBS

BAR GLASS MOUNT BRACKET
1 3/8" DIA



PL-RSP

SWING PIVOT
1 3/8"D / 13 3/4" H



PL-RMFG

FLOOR MOUNT GUIDE
1 3/8"H / 2" L



PL-RLF

MANET LOCK FITTING
4 1/2"H / 2 1/4" W

Tiffany All Glass sliding system
top hung/offset mount



All Glass Top Hung Slider Door/Sidelite System

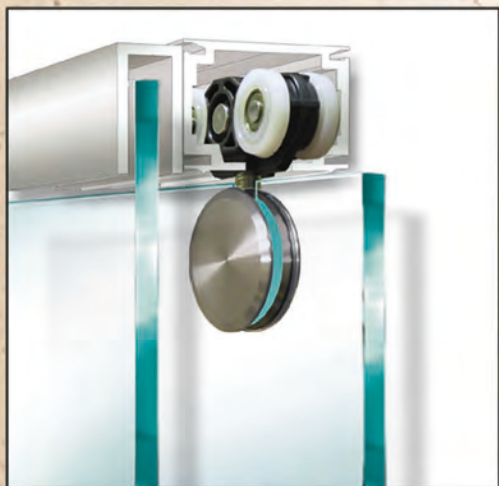

Top Hung Slider Door/Sidelite



Offset Wall Mount Slider Door

Tiffany All Glass sliding system
top hung/offset mount

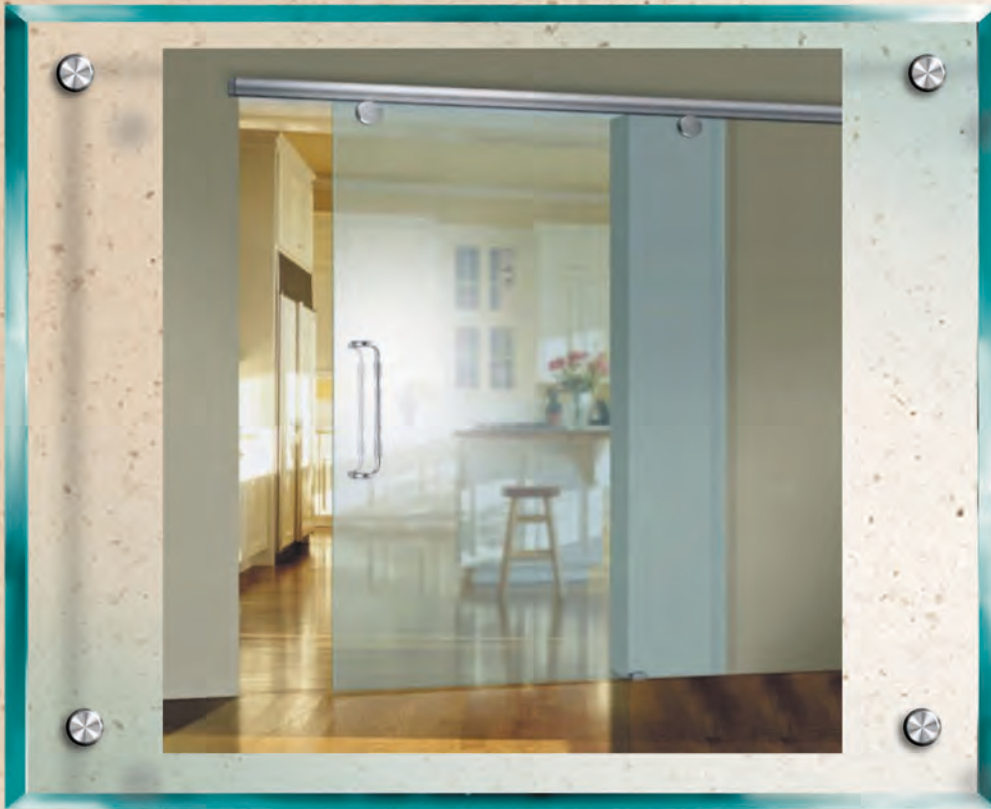

PL-SHTBS
TOP TRACK 2-3/16 X 1-5/8



PL-RSCBS
ROUND SLIDING ROLLER
2 3/8" D



PL-GGLBS
LOCK/STRIKE 1 7/8"D

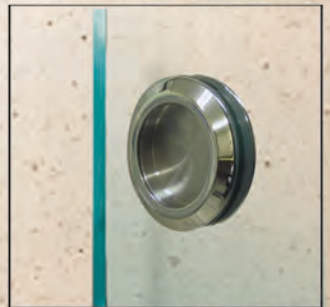

PL-SHBS
FINGER PULL 2 1/4"D



PL-TDGBS
GUIDE FITTING
4 1/2"H / 2 1/4" W



Configurations,

- Single Pocket
 - Hidden Pocket or
 - Lateral Surface mount
- Door/Fixed Panel

Mounting Options,

- Top Hung
 - Concealed/exposed
- Lateral
 - Surface mount

Hardware,

- Flush Mount Finger pull
- Concealed Door Stop
- Floor Guide
 - Surface mount



**Top Hung
Head mount**

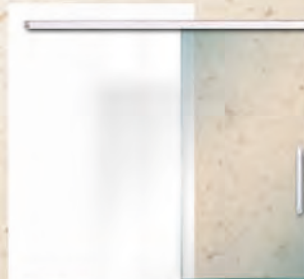

**Top Hung
Side Wall Mount**



P Style bottom roller sliding doors & frameless sidelites



P Style Bottom roller sliding doors/sidelite system



Bottom Roller Systems

PRL **Sliding Systems** offer unlimited options wherever valuable space is critical with,



Top Sliding track
(2 3/8" W x 1 1/2" H)

Single/Multiple Panels

Top/Bottom Rail

Bottom straddle

SQ bolt lock

Tandem roller

Bottom Sliding track
(2 3/8" W x 3/8" H)

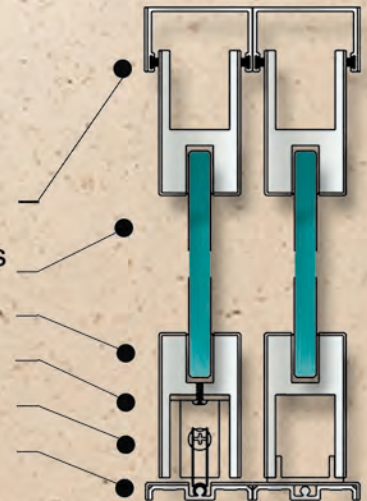

- Single/Multiple Panels
- In-line or Stacking
- Dual Swing/Sliding
- Frameless

PRL Clearvision Stacking Movable Wall System is the perfect solution were total vision is required or the store fronts needs to be open completely. A big advantage to this system is that no floors guides are require and the panels can be moved effortlessly. The system can be parked in many different positions. We will make easy for you just give us the opening dimensions and we will take care of the rest.

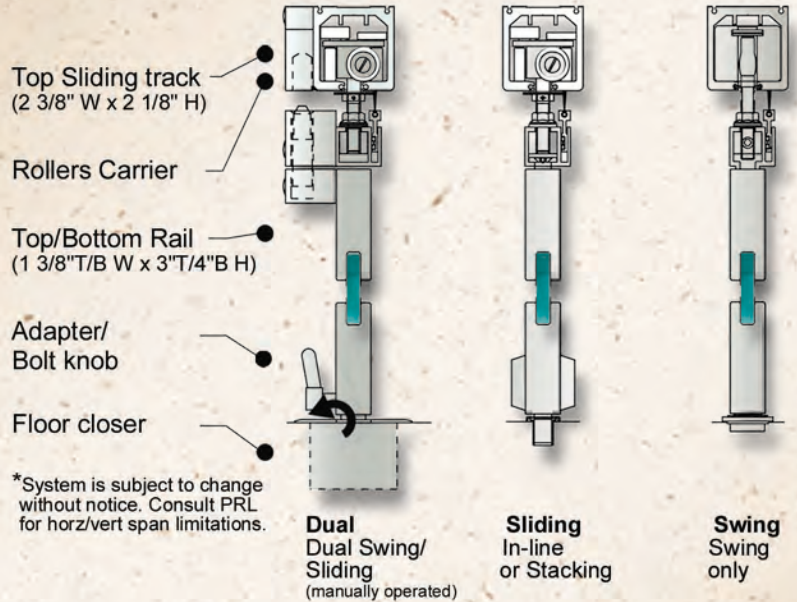

Flexible Top Hung Sliding Systems

- Single/ Multiple Panels
- Top/Bottom rails



All Glass Top Hung Slider/Stacking Door System



Clearvision All Glass Top Hung Slider, Swing, Stacking Door System



Clearvision transparent movable wall frontages can be simply adapted to most job configurations and layouts. The configurations can be straight, angled or curved (segmented system) as this project shown. Clearvision movable wall system can be closed or open and you can still enjoy the views without obstruction.



Full Frame Door with custom centerlock housing, knob/deadbolt lock and side mount pivot bracket.



Custom Top/Bottom Rail Gate with Sandblast artwork and side mount hinges.

Security Gates



Custom Glass Gate w/centerlock housing, Latch lock, lever handle, electric strike & side mount pivot bracket.



PL-CGP

42"H / 4" W

Custom Gate Post clad in #4 Satin SS



PL-SMPB

5"W / 8" H

Custom Side Mount Pivot Bracket in #4 Satin SS

PL-GPUC

1"D / 1" W

Gate post Glass stainless Steel U Channel

Any type of locking specialty hardware can also be accommodated such as,

- Latch locks/lever handles
- Electric/Mechanical access devices

FULL FRAME DOORS



Clad metal/finishes (18ga.)

- Satin & Polished
 - 304 Stainless steel
 - 464 Naval brass
- Oil rubbed bronze(US10B)
- Powder coated
- Custom finishes available

Hardware

- Offset/CH pivots
- OH concealed closer
- Floor closer
- Butt hinges
- Custom pulls
- Panic devices
- Door holders

Glass

- 1/4" to 1/2" tempered or laminated
- 1" insulated units
- Pattern glass

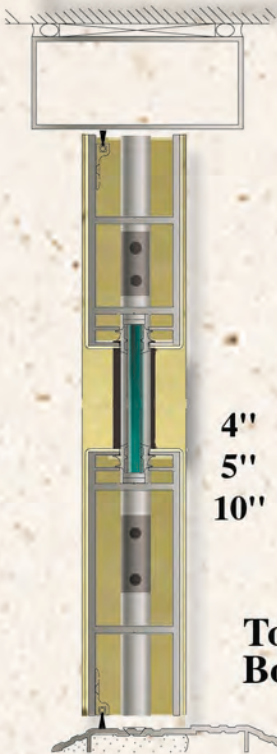

4"
5"
10"

**Top/
Bottom rails**



FULL FRAME DOORS

STYLES



NARROW
3" vertical stile,
4", 5", 10" or
custom height
top/bottom rails



MEDIUM
4" vertical stile,
4", 5", 10" or
custom height
top/bottom rails



CUSTOM
narrow vertical stile, top/bottom
rails, hardware, glass and
sandblast artwork.



MUNTIN
custom intermediate
vertical/horizontal
muntin



STAMPED
Custom Stamped
pattern



WIDE
5 1/2" vertical stile,
5", 10" or
custom height
top/bottom rails



P Style Doors and Storefront frame
cladded in #8 Polished Stainless Steel



Cladded Full Frame Door w/
press-stamped round accents



Custom monumental Doors

PRL offers designers complete custom architectural metal products for unique projects.

The Custom door shown is an oversized sculptural stainless-steel polished mirror door with 12 conical portholes. Frameless, surrounded only by glass, the 7-by-12-foot door rotates on a central pivot, the result of a geometric calculation utilizing the rectangle and the circle, symbols of symmetry, order and simplicity.

PRL offers a wide range of custom break-formed cladding shapes.

Standard sheet sizes are 48" wide in 8', 10' & 12' lengths with various metal types and finishes such as,

Aluminum

Mill, Clear and Bronze

Powder Coat

White

Stainless Steel

8 polished, #4 satin

Naval Brass

Polished & Satin

We also offer custom fabrication, machining and finishing services, as well as variety of std/custom components



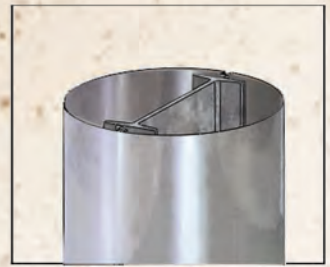

Column Covers

Closed



Panels

Open corner

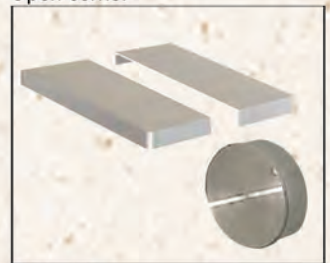

Covers

Welded/finished corners



Channels

Special size/depths



Cladding/Flashing

Storefront



Handrail Shapes

Top Caps/Base Covers

Brakeformed Shapes

- Head/Sill flashing
- Angles
- Hat
- J-Z Shapes
- Open/Closed Corner
- Channel

Metal Finishing

- Mirror Polishing
- Directional
- Satin Brush

Handrail

- Top Cap
- Miter Returns/
Corners
- Connectors

Clad

- Full Frame Doors
- Door Header/Jambs/
T-Holds
- Storefront Framing
- Column Covers
- Cornices
- Panel Pans

PRL's **#1** goal and commitment is to assist our customers with their glass, aluminum and hardware needs (complete systems from PRL) .

Consolidate your aluminum & glass projects and PRL will increase your project management time

= **All in one P.O.**

from **PRL**



Efficiently,

- Write **ONE** purchase order
- Better pricing
- **Fastest Leadtimes** (free local delivery)
- On time shipments
- **Reliability & Quality**
- **Extense Products Lines**



ALUMINUM DOORS



Custom Window



- Aluminum Entrance Doors
- Hardware
- Custom Break-Metal
- Architectural Glass

| | |
|------------|---------------|
| Clear | Tint Uncoated |
| Reflective | Low iron |
| Textured | Spandrel |
| Sandblast | Laminated |
- Custom extrusions
- Complete Storefront
- Finishing
 - Anodizing, Paint/Kynar & Powder coat
- Fabrication/CNC Capabilities
- Fastest leadtimes



Cross Bar
Panic Device
Standard Door



Contempo
Panic Device
Standard Door

ALUMINUM DOORS

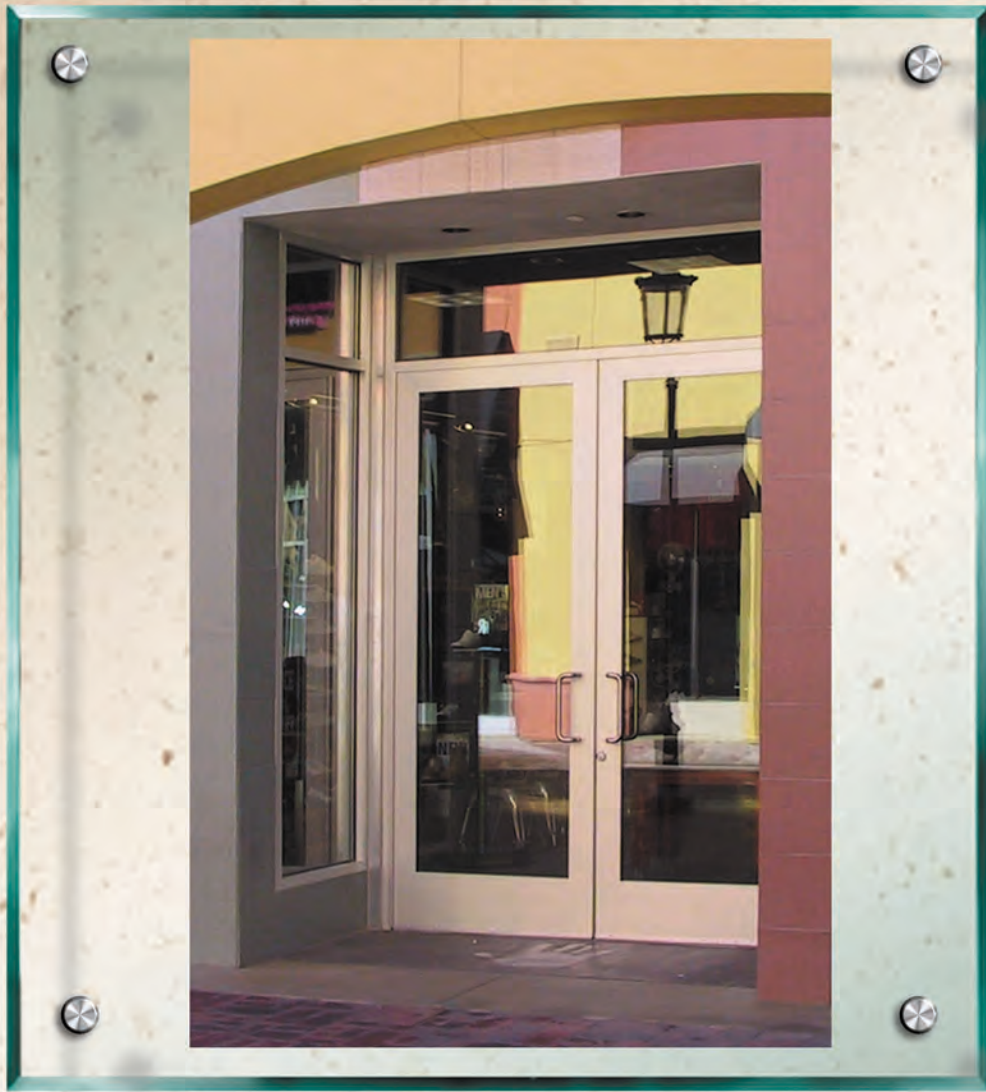

STYLES



NARROW
2" vertical stile,
2", 3 1/4", 5 1/8", 10"
or custom height
top/bottom rails



MEDIUM
3 1/2" vertical stile,
3 1/4", 5 1/8", 10"
or custom height
top/bottom rails



OVERSIZE
Reinforced frame

Aluminum Entrance Doors are available in single acting offset pivot, butt hinge or center pivot operation. High bottom rails may be adapted to all sizes and to meet local codes. All doors are produced to specific size requirements in widths and heights within limits of each specific door.

Narrow, Medium & Wide stiles are the industry standard, All of them offer strong reinforced corner construction for top performance and permits their use in heavy traffic areas of commercial applications.



CUSTOM
Any vertical stile,
top/bottom rail
& intermediate vertical/
horizontal muntins.



WIDE
5" vertical stile,
5 1/8", 10" or
custom height
top/bottom rails



DS-1
Square inner muntin
W/glue chip glass



DS-2
Octagon inner muntin
w/azuria glass
on pocket hdwe



DS-3
Rectangular Muntin frame
w/ artistic bronze glass



DG Series decorative grid

PRL offer style and performance with unlimited adaptability to specific design requirements with Designer Series Doors, symmetrical outer/inner interconnected framing and textured/ artistic glass multiple combinations.

As the standard style doors DS doors will receive most pivot/ hinges, lock and security hardware. Impressive door styles with strength and stability for heavy use. The DS Door series will accommodate most standard and designer hardware to suit any operational/aesthetics requirements.

Some limitations apply please consult PRL Aluminum for details



DS-4
Horz. muntin/beveled
glass stop & masterline
glass

Nu-Vision Aluminum MAX' Sliders



Pocket System

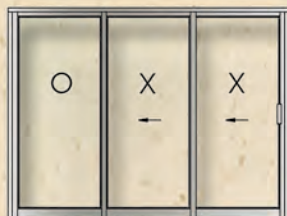

Wall System



Custom System



Multi_Track System



Unit w/Top Hung System & Slender Floor guide

Offering multiple configurations & styles...

Top Hung Roller System

- Custom Configurations
- 1" Ultra Narrow/3" medium stiles
- Custom Hardware
- Top Hung or Side mount Head track
- Exposed/Concealed Head tracks
- Retractable Mechanism
- Bottom Seal/Slender floor guide
- Standard Bottom Guide/Sill
- Centerlock housing (UN Stile only)
- Standard 1 1/4" IG Glass

- 1" Ultra Narrow Stile

- Concealed Slender floor guide

extruded/mfg. in house



ALUMINUM SLIDER DOORS

PRL SL Series is a sliding door system designed as a versatile framed stacking system with a head/sill track, vertical jambs that allows unlimited adaptability with basic single pocket to multi slider configurations for areas where valuable space is critical.



Hardware

Bottom adjustable tandem rollers system will ease the open/close sliding efforts. Combination of weather stripped vertical stiles/head track and sill track minimizes the weather effects on exterior applications.

SL series standard hardware are flush handles, hooklock and cylinders. Other types of hardware are offered as options such as flush lockset or custom pulls

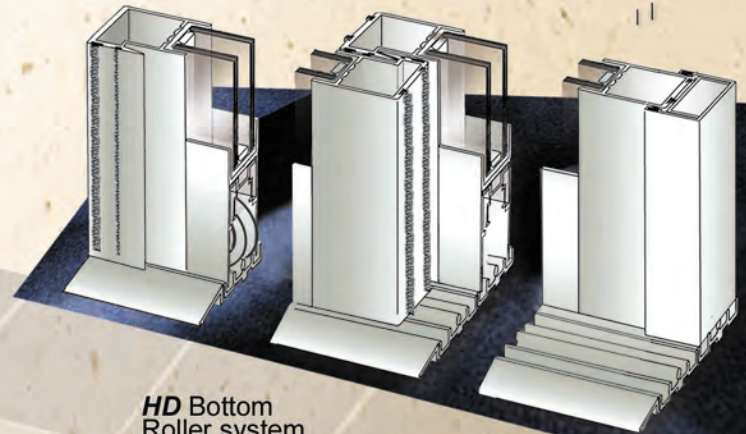

PRL GLASS SYSTEMS

HD Bottom Roller system

(800) 433-7044

www.prlglass.com



PRL technical assistance will save you time and effort coordinating the concept, design, material selection and evaluation of technical considerations necessary to manufacture functional complete systems with all related mechanical devices and ensure full compliance to specifications.

PRL uses the latest CAD/CAM to produce shop drawings, layouts, details and specifications on entrance systems.

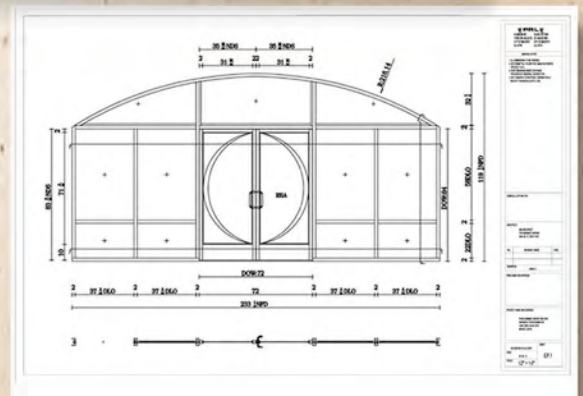

250 SERIES

2" x 4 1/2"
1" CENTER GLAZED

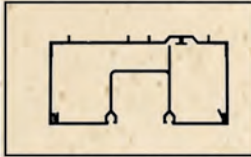

HEAD
NAME
PART NUMBER
LENGHT

| |
|---------------|
| HEAD ASSEMBLY |
| 250HCA |
| 24'-1" |

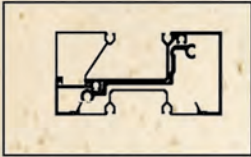

HORIZONTAL
NAME
PART NUMBER
LENGHT

| |
|-------------|
| HZ ASSEMBLY |
| 250HMA |
| 24'-1" |

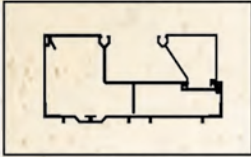

SILL
NAME
PART NUMBER
LENGHT

| |
|-------------|
| SC ASSEMBLY |
| 250SCA |
| 24'-1" |

400 SERIES

1 3/4" x 4"
1/4" CENTER GLAZED

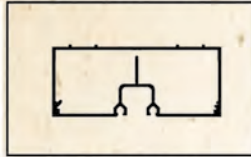

HEAD
NAME
PART NUMBER
LENGHT

| |
|---------------|
| HEAD ASSEMBLY |
| 400HCA |
| 24'-1" |

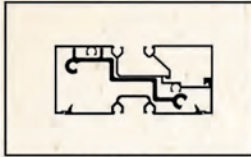

HORIZONTAL
NAME
PART NUMBER
LENGHT

| |
|-------------|
| HZ ASSEMBLY |
| 400HMA |
| 24'-1" |

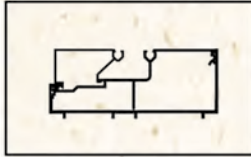

SILL
NAME
PART NUMBER
LENGHT

| |
|-------------|
| SC ASSEMBLY |
| 400SCA |
| 24'-1" |

450 SERIES

1 3/4" x 4 1/2"
1/4" CENTER GLAZED

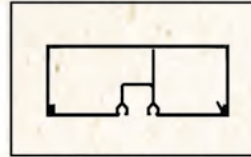

HEAD
NAME
PART NUMBER
LENGHT

| |
|---------------|
| HEAD ASSEMBLY |
| 450HCA |
| 24'-1" |

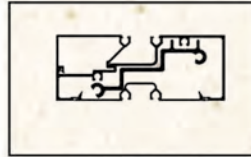

HORIZONTAL
NAME
PART NUMBER
LENGHT

| |
|-------------|
| HZ ASSEMBLY |
| 450HMA |
| 24'-1" |

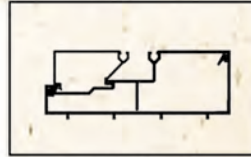

SILL
NAME
PART NUMBER
LENGHT

| |
|-------------|
| SC ASSEMBLY |
| 450SCA |
| 24'-1" |

201 SERIES

2" x 4 1/2"
1/4" OFFSET GLAZED

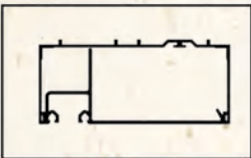

HEAD
NAME
PART NUMBER
LENGHT

| |
|---------------|
| HEAD ASSEMBLY |
| 201HCA |
| 24'-1" |

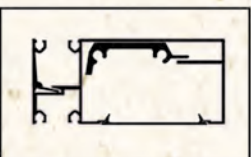

HORIZONTAL
NAME
PART NUMBER
LENGHT

| |
|-------------|
| HZ ASSEMBLY |
| 201HMA |
| 24'-1" |

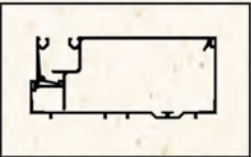

SILL
NAME
PART NUMBER
LENGHT

| |
|-------------|
| SC ASSEMBLY |
| 201SCA |
| 24'-1" |

251 SERIES

2" x 4 1/2"
1" OFFSET GLAZED

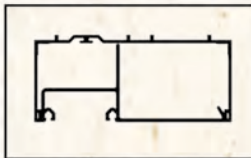

HEAD
NAME
PART NUMBER
LENGHT

| |
|---------------|
| HEAD ASSEMBLY |
| 251HCA |
| 24'-1" |

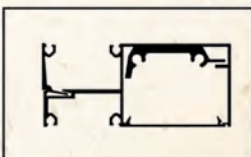

HORIZONTAL
NAME
PART NUMBER
LENGHT

| |
|-------------|
| HZ ASSEMBLY |
| 251HMA |
| 24'-1" |

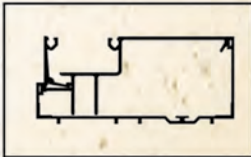

SILL
NAME
PART NUMBER
LENGHT

| |
|-------------|
| SC ASSEMBLY |
| 251SCA |
| 24'-1" |

401 SERIES

1 3/4" x 4"
1/4" OFFSET GLAZED

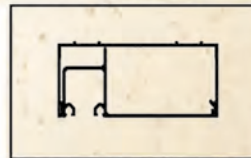

HEAD
NAME
PART NUMBER
LENGHT

| |
|---------------|
| HEAD ASSEMBLY |
| 401HCA |
| 24'-1" |

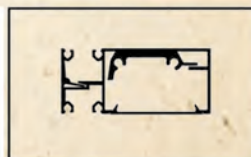

HORIZONTAL
NAME
PART NUMBER
LENGHT

| |
|-------------|
| HZ ASSEMBLY |
| 401HMA |
| 24'-1" |

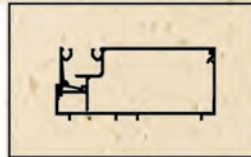

SILL
NAME
PART NUMBER
LENGHT

| |
|-------------|
| SC ASSEMBLY |
| 401SCA |
| 24'-1" |

MATERIAL: 6063-T5 aluminum alloy.

FINISH: Standard finishes are mill, clear and bronze anodized. All others are special order.

NOTES: Storefronts are available in quick set or screw race, please consult PRL aluminum for details

Curtain Wall Series

Designed and engineered for maximum performance with the highest quality assurance. Suitable for low, mid and high-rise applications

- versatile
- energy efficient
- custom design adaptable
- fastest design/mfg leadtimes



PL-CW Series

2 1/2" x 6"
 2 1/2" x 7"
 2 1/2" x 10"
 1" OFFSET GLAZING

low rise



HEAD

mid rise

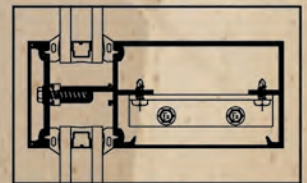

HORIZONTAL

high rise

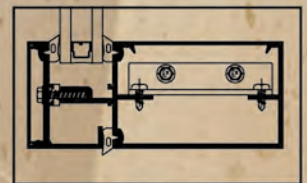

SILL

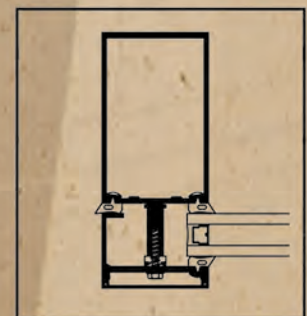

JAMBS

The PL-CW600, 700 & 1000 series is a pressure glazed or structural silicone glazed system designed to efficiently exceed all industry standard performance requirements.

All the system components are designed to allow interchangeability making them ideal for complex visionary architectural designs. The Series are designed to compliment PRL's storefronts and standard entrance doors that utilize all hardware and door types with single or double action doors.

The system is designed to receive standard 1" insulating glass and 1/4" spandrel glass in a 1 1/2" glass pocket. It can also utilize glazing thickness from 3/8" to 1 1/2" depending on your needs. Thermal break construction exceeds all new energy codes, Cal title 24/IECC etc.



The new Curtain Wall series are an example of our Design/Engineering & Full Manufacturing in house capabilities

...We offer,

- Building Envelope Design
- Stick & Modular systems
- Custom/Std Curtain Wall Systems
- Structural Aluminum framing
- Integral sunshades
- Engineering
- Title 24 expertise
- Welding
- Machining
- Finishing

Accessories,

- Custom Metal mounting brackets
- Mechanical Attachments
- Custom components

& more...

Aluminum Press

PRL's State of the art 2400 tons/8"

- Custom designed extrusions
- up to 9-1/2" diameter shapes extrude
- Fabrication/CNC Capabilities
- Fastest leadtimes in the industry*

CNC Division

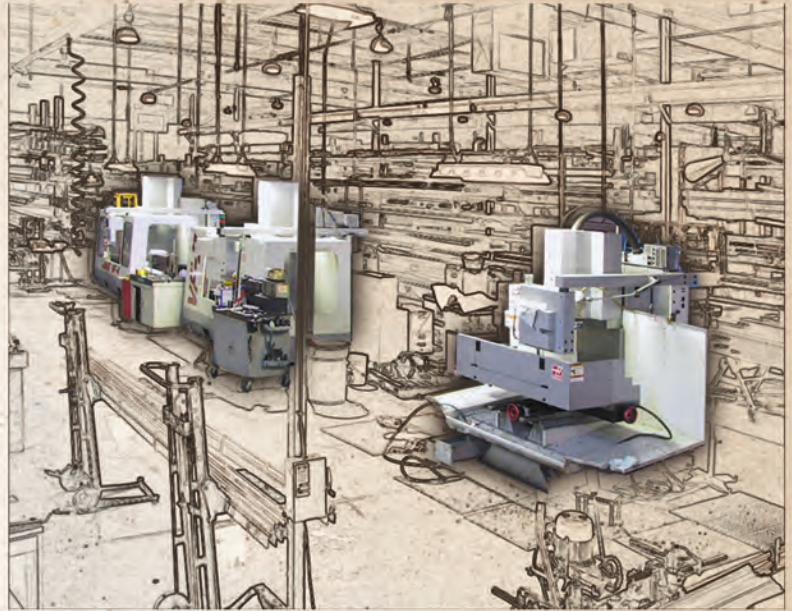

Over 40 state of the art machines at service our new Architectural metals machining capabilities allows us, to fabricate all components in house to meet the industry needs.

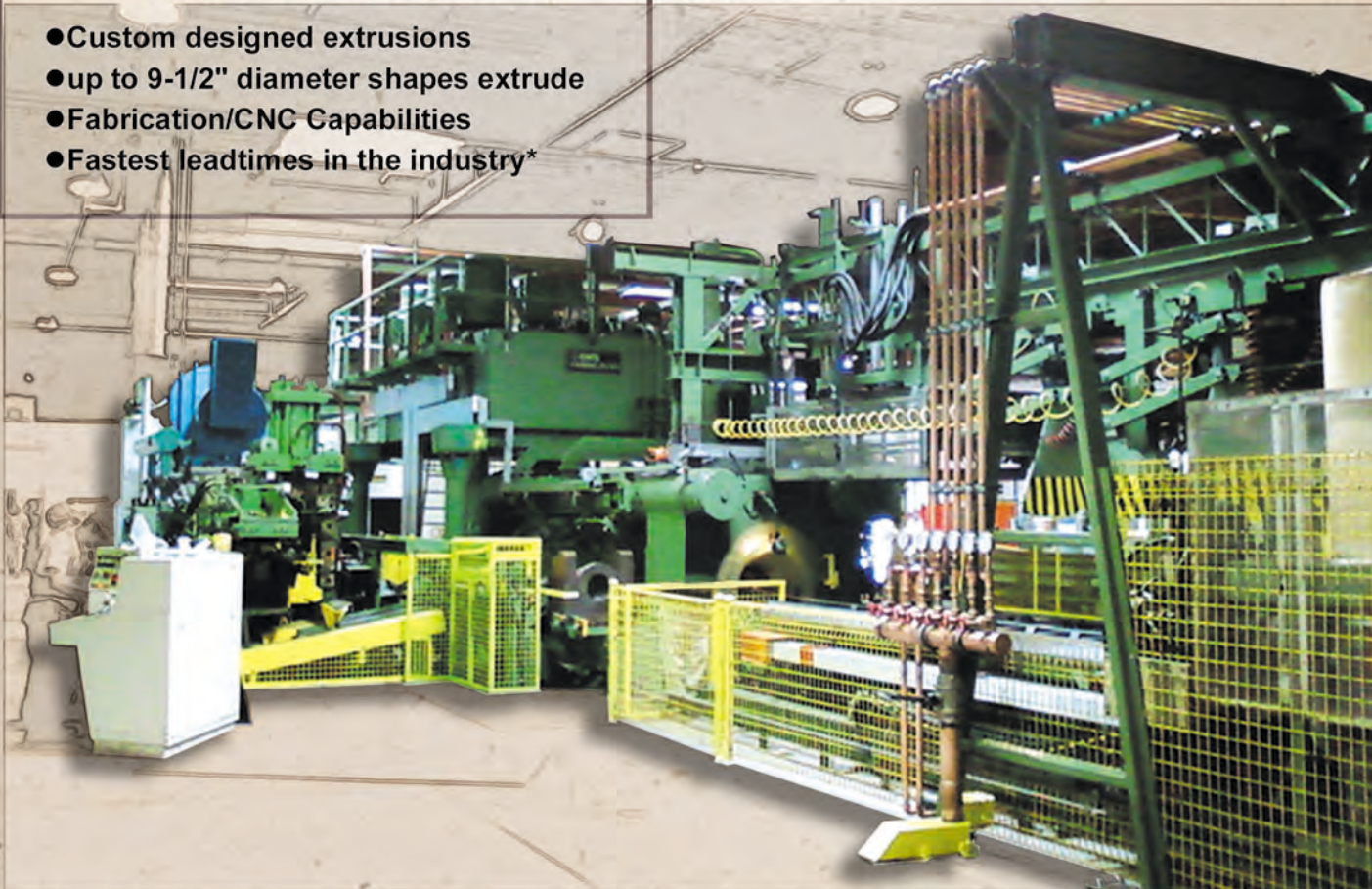

GLASS

INSULATED GLASS UNITS

Total energy performance units features

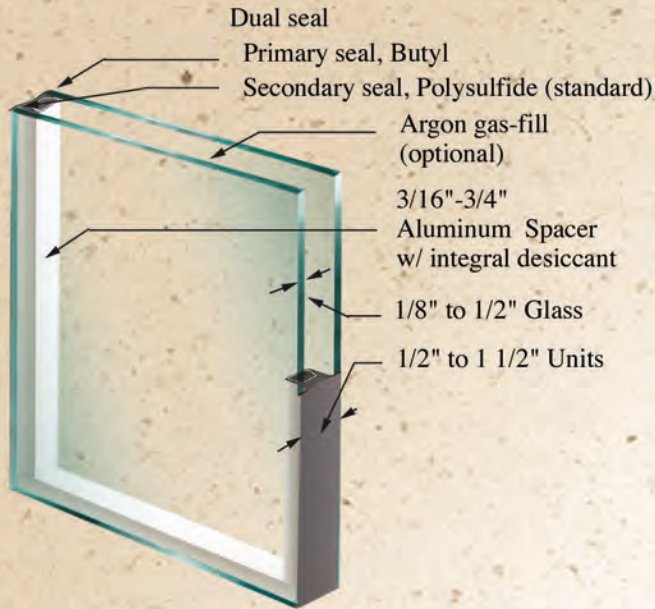

PRL I.G. Units are a high quality, total energy performance product that translates into reduced energy cost and increased comfort.

Applications

Insulated glass helps to maintain inside room temperatures while saving energy.



Residential



Grids



Shapes



Commercial



Sculptured Grid



Standard Grid



Super Spacer®

IG Unit Performance

IG Units performance values are a result of a combination of options (glass types, air space, surface orientation, etc.,). The use of low E glass and reflective achieve a higher performance values. Please consult **PRL** glass for details.

Common Insulating

Provides heat/cold insulation, condensation and soundproof resistance

Spacers/Grids

- Super-Spacer also available
- Standard Spacer (3/16" x 5/8"-3/4" white or brz)
- Sculptured shape grids available (5/16" x 1" white)

I.G. Unit line capabilities

- Max. sizes 137" x 87"
- Min. size 6" x 6"
- Thickness from 1/2" to 1 1/2"

25% Interior Filtrated Energy Transmission thru PRL'S I.G. Unit*



100% Exterior Energy Transmission

Low E Reflective



Certified

PRL GLASS SYSTEMS

(800) 433-7044

www.prlglass.com

201 SERIES
2" x 4 1/2"
1/4" OFFSET GLAZED

400 SERIES
1 3/4" x 4"
1/4" CENTER GLAZED

401 SERIES
1 3/4" x 4"
1/4" OFFSET GLAZED

450 SERIES
1 3/4" x 4 1/2"
1/4" CENTER GLAZED

REFLECTIVE

A pyrolytically-coated glass for improved solar control. Available in 1/4" or in other thicknesses if *noted.



Solarcool Azuria



Green 2000T

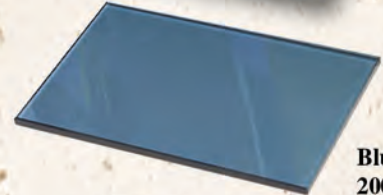

Blue 2000T



Blue RC



Evergreen Eclipse Advantage LOW_E

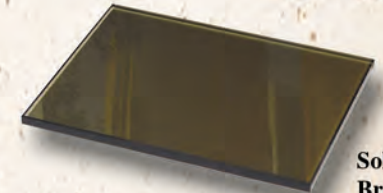

Solarcool Bronze *3/16"



Blue 2000R



Mirror Pane



Green RC

TINTED UNCOATED

Provides excellent solar control with a versatile range of tints. Available in 1/4" or in other thicknesses if *noted.



Azuria *3/8" and 1/2"



Bronze *1/8", 3/16", 3/8" & 1/2"



Solexia/Green *1/8"



Blue

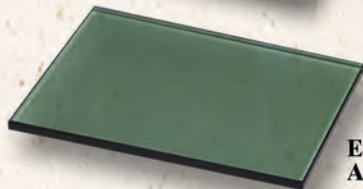

Evergreen/Antlantica



Super Gray



Blue Green *3/8"



Green 2000



Blue 2000



Gray *1/8", 3/16", 3/8" & 1/2"

we carry a full line of architectural glass
*consult us for details

Note: Samples shown are for illustration purposes only, colors may vary from actual samples. Performance data is available upon request. Please consult PRL for details & availability.

Architectural



SPANDREL GLASS Its offered with, ICD OPACI-COAT 300 water based silicone coat, which is not heat-treated.

Applicable on annealed, tempered glass, and reflective products. Available in standard and custom of colors, Please contact us for details.

SPANDREL in an almost unlimited range of colors offers a variety of options for interior glass applications. Used on clear or reflective glass it can add a radiant, jewel-like color to commercial or residential interior applications.



#0-0186
Light White/Clear Glass
shown



Wall Clad & Interior applications



Standard Colors

-  #1-818 Black
-  #3-820 Harmony Gray
-  #4-822 Harmony Bronze
-  #6-0025 Harmony Blue
-  #2-743 Harmony Solex
-  #4-975 Lava Bronze
-  #2-0225 Evergreen
-  #0-0186 Light White
-  #0-0020 Snow White
-  #0-1060 Primary White
-  #1-0016 Charcoal
-  #3-0586 Medium Gray
-  #3-0770 Warm Gray
-  #3-747 Harmony Graylite #14
-  #3-967 Black-Gray
-  #4-0925 Neutral

Custom Colors

-  #2-0213 Aged Copper
-  #6-0194 Fjord
-  #5-936 Red

Note: Samples shown are for illustration purposes only, colors may vary from actual samples. Please consult PRL for details and availability.



Spandrel Custom Color Wall clad



Spandrel Custom Color Wall clad



PRL offers complete contemporary railing systems options. Elegante stand-off are available in stainless steel or Powder coat. We also offer custom components as well as custom fabrication, machine and finishing services

Offset Glass mount

Wall or glass Mount Tubular Handrail

Custom Design



PL- HR20XCGPS
BRACKET WM-GLM
for 1 1/2" Dia. rail



PL-HR15RE/HREC
90 deg. 1.5" Dia./Endcap

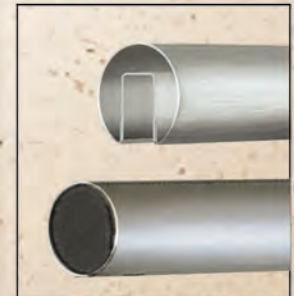

PL- TCBS/15T
1 1/2" to 4" Dia./1 1/2" Dia.



PL-RSOB2134BS
2" Dia.
Round/Flat cap



PL-RSOBD20BS
4"w x 8" h
Round/Flat cap



PL-HR135E
1.5"/1.9" Dia.

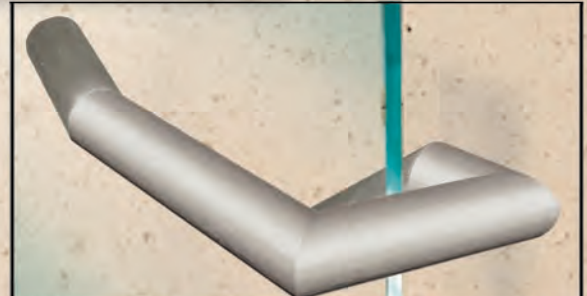

PL-HRCE
1.5"/1.9" Dia.

Traditional Wet-Glazed



Top Cap GR/glass offset mount HR



Windbreak w/ Sandblast artwork



PRL offers a traditional transparent Guardrail/Handrail system with great strength that will enhance the architecture of enclosed or open spaces.

- Traditional single piece base
- High strength compression cement wet-glazing method
- Mill, Anodized, Powder coat and Clad finishes
- Stock Sizes 10' 12' & 20'

All PRL's Guardrail/Handrail systems are utilized as a structural baluster, 3/8" or 1/2" flat tempered glass with clear, bronze and grey as color options or 9/16" bent/laminated (textured and laminated patterns are also available upon request).

other glass options are,

- 9/16" bent/laminated
- Custom Sandblast
- Textured
(custom patterns are also available upon request)

- Design/technical assistance
- Shop drawings



PL- HRB/ PL-ATC
2 1/2" w x 4 1/8" h Base / Alum Top Cap

Rapid Dry-set

GUARDRAILS/HANDRAILS

PRL's innovative dry-set system offers,

- Shoe Base Lighter
- Optional Clad Fascia
- Stock Length Sizes 10' 12' & 20'
Custom Sizes Available
- Fast, Easy Reduced labor Installation
- No Additional / Special Tool Required
- Plumb Adjustment Up To
5/8" (Vertically) - 5/8" (Right Side)

As a baluster system, the strength depends on a proper mount to a structural element such as a steel frame or concrete, various methods are suggested (top, side or flush mount).

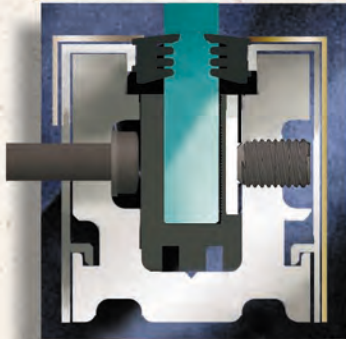

PL- DSMHRB
2 1/2" w x 2 3/4" h

Test reports/
Certificates
are available
upon request

We **extrude** our own HR base and offer complete systems with **glass**. Available finishes are,

- Anodized • Mill • Clad (Brass/SS)

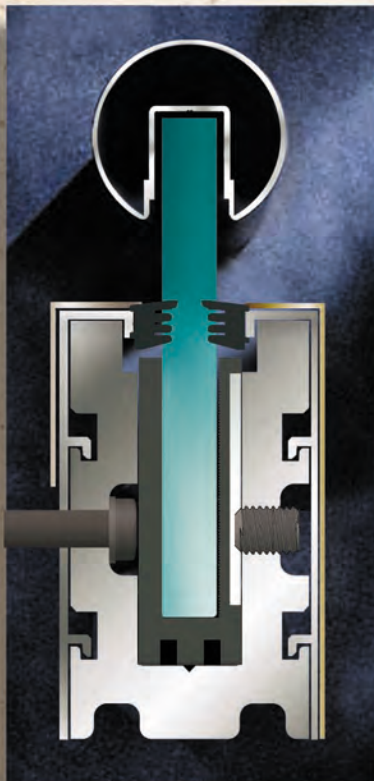

PL- DSHRB / PL-TC
2 1/2" w x 4" h / Top Cap



Handrail top cap/dsmhrb

Guardrail/clear glass

Handrail top cap/dshrb

Infinity Series

Infinity standard aluminum railing provides for a variety of configurations with unique continuous top rail styles and is engineered for strength.

Powder coated for environmentally friendly durability and low maintenance in a color to match your project or a variety of standard and custom colors.

Our glass railing is the perfect solution for when unobstructed views are desired offering a unique design and ease of installation.

We **extrude** our own systems offering a complete system with **glass**. among other applications are,

- Standard Glass Railing
- Topless Glass Railing
- Fencing
- Custom Railing
- Handrail
- Pool Surrounds
- Wind & Privacy Wall
- Gates



200 Series Railing



Infinity Series

Quality and Strength

Infinity Railing are Fabricated with the highest grade extruded Aluminum, 40 times stronger than wood. Aluminum is one of the sturdiest material that exists in North America. This railing can handle tough weather conditions which it prevents rusting.

Infinite Series Railing is engineered to provide maximum strength using: ASTM 6063-T5 or 6005A-T6 Aluminum.

Systems

The Infinity Railing welded system is the most cost effective, yet offers many pleasing qualities to your project. This system is not only vibrant to the eye, but it easily adapts to any proposal.

Choose the top rail that best fits your design/application and works the finest, out of the four we have provided.

Finishes

Architectural Metals Designed, Engineered and Manufactured By PRL with a high-end powder coating to provide the highest performance from Corrosion, Heat, Impact, Abrasion, Fading and Weather Conditions.

Standard Colors

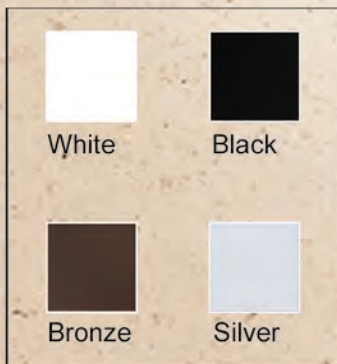

Custom colors available upon request, please consult PRL for details.

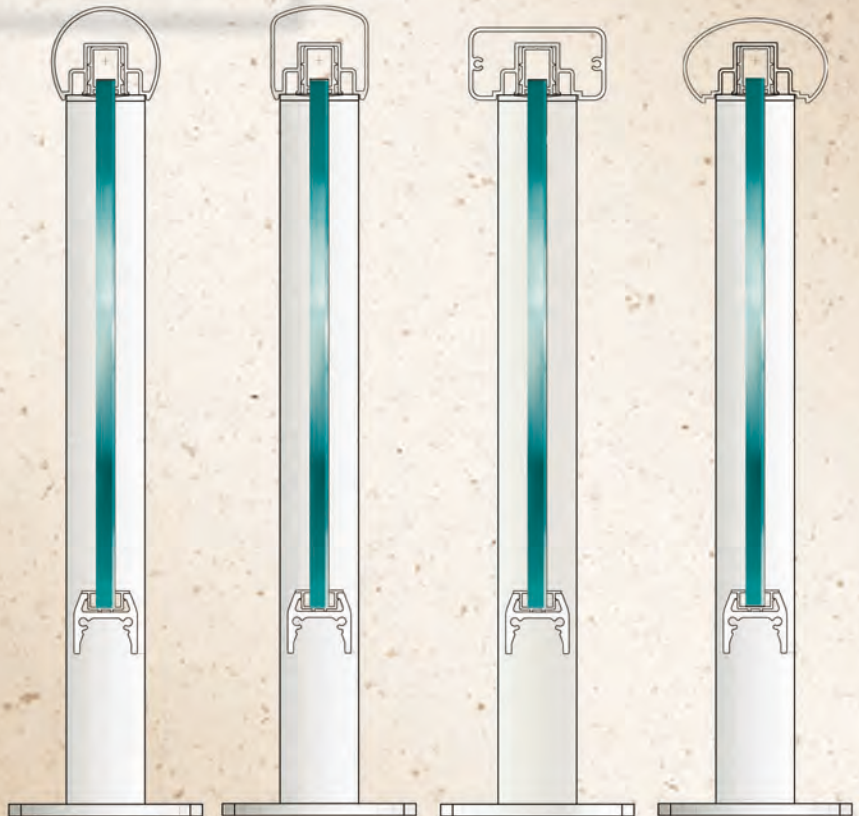

200 Series

250 Series

300 Series

350 series

Nu-Vision are fabricated in detail to practically any geometric configuration. These are some examples,



90 Degree



Steam unit/transom



Steam unit enclosed



Custom Notch



Custom Gluechip Border



Steam unit/Vent

Nu-Vision are fabricated in detail to practically any geometric configuration. These are some examples,



90 Degree



Slider



Splash panel



Sandblast Artwork



Custom Gluechip Border



Textured Glass

TUB / SHOWER SLIDERS

Nu-vision shower sliders are offered in 1/4" & 3/8" glass thickness, in 60" tub/72" shower slider standard heights or custom configuration to fit almost any field condition.

Sliders are assembled with precision engineered metal extrusions for heavy glass loads. Available finishes are,

- Bright-dipped silver/gold
- White powder coat
- Plated brushed nickel
- Anodized



PRL

SHOWER GLASS

with a Permanent Coating

is a Technology that

Innovates

All-Glass Shower

Enclosures &

maintains the **NEW**
appearance longer at
an **unbeatable cost.**

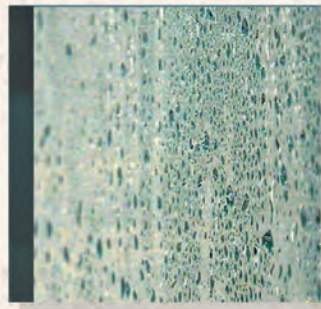

**Glass surface
with coat**

**Glass surface
without coat**

Values,

- Easier to clean
- Glass looks newer longer
- Combats corrosive effects of moisture & Mineral deposits
- No more soap build up
- No peeling or discoloration
- Normal maintenance will keep the glass clear and looking beautiful
- Permanent protective coating that does not require to be re-applied
- 10 Year warranty

Available in 1/4", 3/8" & 1/2"



Clear



Low Iron

The new technology (permanent protective coating) seals the glass surface so that it is more resistant* to the corrosive action of moisture, humidity and chemicals found in many household cleaners.

*Must be maintained per mfr. recommendations



PRL GLASS SYSTEMS

(800) 433-7044

www.prlglass.com

Note: Samples shown are for illustration purposes only, color/designs may vary from actual samples. Please consult PRL for details and availability.

Euro-MasterGlass Series



Low-Iron Krystal Glass Series



A complete & *Exclusive* **PRL** line

Offering all Options and standard finishes

Hinges

Wall mounts



135-180 Degree



Pivot



Pulls



Pull/T-Bar



Knobs

Krystal Series



Clamps



Headers



U channels

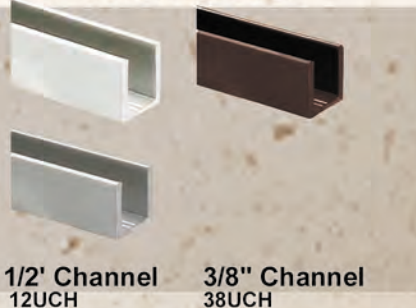

Seals



PRL New!

State of the art Laminated line is coming this **summer!**

to our new **facility**



City of industry, CA

PRL GLASS SYSTEMS
251 MASON WAY
CITY OF INDUSTRY, CA. 91746

This **Laminated line** will increase **PRL** production capabilities



offering,

- **Safety**
 - Fire retardance
 - Burglary
 - Ballistics-Projectile
 - Storm Resistance
 - Code Hazardous Glazing

Sizes 96" x 153" up to 3" thick

- **Aesthetics**
 - Color
 - Patterns
 - Graphics
- **Performance**
 - Sound STC ratings
 - PBV interlayer UV protection
 - Graphics

Call us,

(877) 775 2586

fx (877) 274 8800

www.prlglass.com