



PRL

GLASS SYSTEMS
www.prlglass.com

Aluminum ARCHITECTURAL PRODUCTS
www.prlaluminum.com

Complete Glazing Solutions

IF SPEED MATTERS!
We offer the Fastest Leadtimes

*Consult PRL for details

ARCHITECTURAL GLASS

with the fastest **LEADTIMES** in the industry guaranteed!



IG Units with Spandrel Glass



3/4" Custom Glass with Gradient Sandblast



Accordion Bifold Aluminum Slider with IG Units

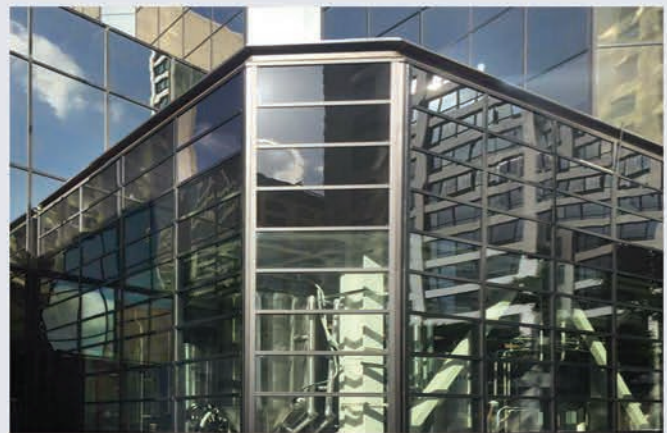

Reflective Glass



Heavy Tempered Low Iron Glass



Laminated Color Glass

for estimates & orders

ph. 800-433-7044

fx. 626-968-9256

www.prlglass.com

CAT-AGE

ARCHITECTURAL GLASS

with the fastest **LEADTIMES** in the industry guaranteed!

PRL GLASS PRODUCTS

Solarban® Low-E Glass (pg. 06)

*1/4", 3/16" Solarban® 60
3/16" Solarban® 70
3/16" Solarban® 90*

Fire Rated Glass (pg. 18)

Samson Hydraulic Glass Door Patch Fitting/Closer (pg. 84)

Thermally Broken Max Aluminum Slider (pg. 112)

Frameless Shower Sliders (pg. 141) *Ruby & Tiffany*

Rapid Dryset HR Base Improved Design (pg. 145)

PLEASE NOTE: PRL continuously improves product design and performance, we reserve the right to make changes without notice.

CONTENTS:



CLEAR PG 04



LOW E PG 06



TEXTURED PG 08



TINTED *Uncoated Glass*PG 10

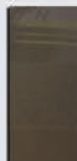

REFLECTIVE PG 11



FIRE RESISTANT GLASS..... PG 18



TEMPERED PG 22



IG UNITS PG 28
Energy Performance



LAMINATED PG 34
*Sound Control
Decorative Glass
Rainbow Color Lami Glass
SentryGlas®
Bullet Resistant
Hurricane Impact Rated*



SPANDREL PG 50
*Color Glass
OPACI-COAT COATED GLASS*



MIRROR PG 56



CUSTOM PG 60
*Sandblast/Gluechip
Tabletops
Glass Specialties*

COMPLETE SYSTEMS ALSO AVAILABLE



ENTRANCE DOORS PG 76
*All Glass Doors
Panic Device
Deadbolt Locking Mechanism
Easy Locking Ladder Pull
Full Frame Cladded Doors
Ultra Narrow Cladded Doors
Aluminum Doors*



ALUM. & GLASS SLIDERS PG 106
*Accordion Bifold Aluminum Systems
Max Aluminum Slider
Alumi Slider
Ruby Slider All Glass
Tiffany Slider All Glass
Quartz All Glass Slider
Clearvision Glass Slider
Classic All Glass Slider
Classic Full Frame Slider*



SHOWER DOORS PG 132
*Frameless Shower Units
Contour Shower Sliders
Frameless Shower Sliders*



HANDRAIL SYSTEMS PG 142
*Top Caps
Shoe Base
Elegante Stand-off
Infinity Railing
Flex & Custom Post
Custom Gates*



ALUMINUM PRODUCTS PG 152
*Storefront Systems
Aluminum Curtainwall
Aluminum Extrusion
Breakmetal*

COMPANY TERMS- Sales, Credit & Warranties

TERMS OF SALE

- VOLUME PRICING:** We welcome special quotation requests for large quantities of glass and mirror. All price quotes are subject to large quantity discounts. Please consult office for pricing.
- MINIMUM ORDERS:** \$25.00 Minimum Order (per Invoice)
\$100.00 Minimum Combined Order for Free Local Delivery.
\$1,500.00 Minimum To Ship To An Address Other Than The Billing/Business Address.
\$2,500.00 Minimum Order for Jobsite Deliveries.
\$5,000.00 Minimum Ordered with PRL per year to qualify for free local delivery
- There is no delivery charge on an order which meets the minimum charge & is within our standard delivery area & schedule. Please note PRL will only deliver to commercial locations.
- HANDLING CHARGES:** Oversized glass may be subject to handling charges.
- MINIMUM CHARGES:** Glass Pricing
Any glass less than 2.0 sq. ft. will be quoted as 2.0 sq. ft. minimum
(3.0 sq.ft on I.G Units and Laminated Glass)
Footage is calculated rounding up to the next even square inch.
- PACKAGING CHARGES:** Wooden crates or cardboard wrap are available.
- EXPEDITING CHARGES:** Expedited leadtimes may be available at an additional cost. Consult us for details.
- QUOTES:** Quotes are good for 30 days, unless special arrangements have been made.
- SPECIFICATIONS:** All glass supplied conforms to ASTM C1036
- CUSTOMERS GLASS /MERCHANDISE:** While working on, or handling customer's glass/merchandise, PRL Glass Systems is not responsible for damage or breakage that may occur to glass or merchandise.

ALL PRICES ARE SUBJECT TO CHANGE WITHOUT NOTICE

TERMS OF CREDIT

- CREDIT:** Credit must be established prior to delivery of merchandise. Orders must be delivered C.O.D. until credit can be approved and an open account has been established.
- TAXES:** All orders will be charged sales tax unless a resale certificate is on file in our office. Please send exemption card with initial order.
- LIABILITY:** Custom orders require a 50% deposit at time of the order and always considered non-cancelable, nor will any portion of the deposit be returned or credited.
- DAMAGE:** All claims for damage (scratches, chips, etc.) must be made within 48 hours of shipment. NO MERCHANDISE IS TO BE RETURNED WITHOUT PRIOR APPROVAL FROM PRL GLASS SYSTEMS.

WARRANTIES

PRL does not warranty glass breakage under any circumstances. Copies of the full disclosure limited warranty for each product are available upon request.



(800) 433-7044

www.prlglass.com

COMPANY TERMS- Specifications on Glass

WEIGHT

1/8"	1.63 Per lb. per sq.ft.	3/8"	5.05 Per lb. per sq.ft.
3/16"	2.45 Per lb. per sq.ft.	1/2"	6.40 Per lb. per sq.ft.
1/4"	3.20 Per lb. per sq.ft.	5/8"	8.25 Per lb. per sq.ft.
5/16"	4.13 Per lb. per sq.ft.	3/4"	10.10 Per lb. per sq.ft.

TOLERANCES:

1. Dimensional

Clean Cut Swiped:

1/4"	3/8"	1/2"	5/8"	3/4"
±1/16"	±3/32"	±1/8"	±3/16"	±3/16"

Machined Edges:

1/4"	3/8"	1/2"	5/8"	3/4"
±1/16"	±3/32"	±1/4"	±1/4"	±1/4"

2. Thickness:

1/4"	3/8"	1/2"	5/8"	3/4"
±1/32"	±1/32"	±1/32"	±1/32"	±1/32"

All glass supplied is graded to conform industry standards

If closer tolerances are necessary, please specify on order. Special tolerances are subject to premium charge.

ORDERING MITERS:

- Miters are calculated by how many degrees are taken off the 90° square edge or angle (see *Image 1*).
- Miters should be expressed as the angle taken off (see *Image 1*).
- Glass width measurement shall be given from long points of glass as shown (see *Image 2*).
- Drawings sent should indicate back or face miter view with degrees.

Image 1:

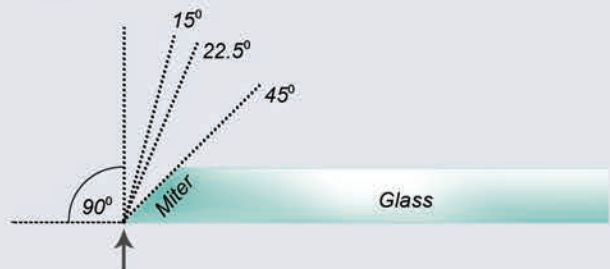
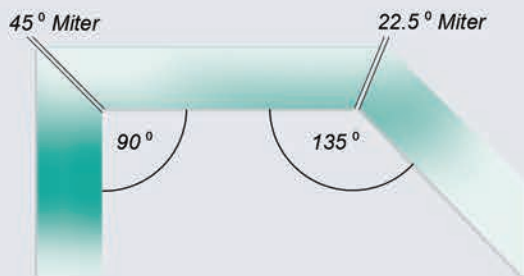
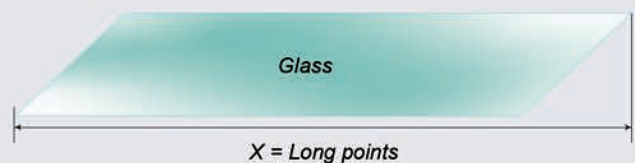

Image 2:



Typical 90° & 135° miter glass joints. Miter edge is generally a flat grind finish in these applications. Exposed miters are generally flat polished.

GLASS SELECTION



Clear Laminated SentryGlas®

At PRL, our vast capabilities allow us to produce an extensive selection of glass products to satisfy all of your project requirements.

PRL offers one of the widest Glass selections in the industry, including clear, starphire, tinted, reflective, low iron, low-e, shower glass, textured and mirrors. Available thickness from 1/8" to 3/4" depending on the product. We can produce tempered, insulated or laminated in a high assortment of combinations using tints, textures or colors providing an endless source of possibilities to achieve your most creative architectural objectives!

Where privacy or partial transparency is desired our textured, patterned or custom glass is the perfect solution. Utilizing our sandblast or glue chip lines, your corporate name or logo can be incorporated into your entrance doors and glass.



Wall Divider with 3/4" Custom Gradient Sandblast Glass

Daily, our goal is to always provide our customers with the most diverse selection of glazing options along with the fastest service possible.

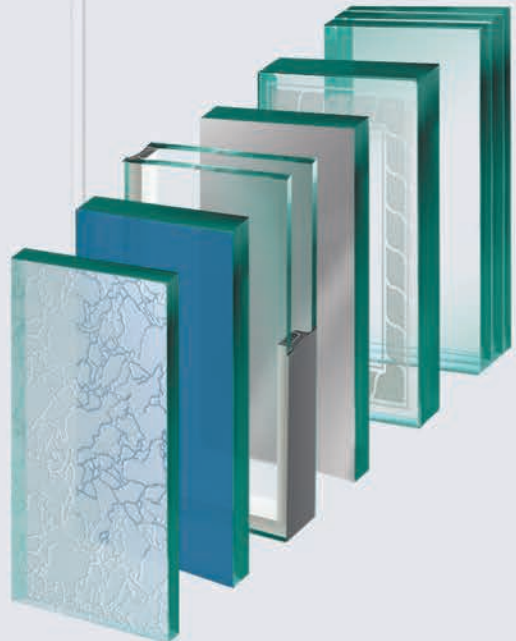

GLASS SELECTION- Clear & Low Iron



All Glass Conference Room with 3/4" Clear Glass



CLEAR GLASS

Offers excellent optical properties with high visible light transmittance

Available thickness:-
1/8", 3/16", 1/4", 3/8",
1/2", 5/8" and 3/4"



LOW IRON GLASS

Practically colorless glass for unlimited applications

- Starphire
- Diamante
- Opti-White

Available thickness:-
3/16", 1/4", 3/8", 1/2",
5/8 and 3/4"

Note: A tint may be more apparent on large or thickness pieces.



Shower Unit with Low Iron Glass

PRL GLASS SYSTEMS

(800) 433-7044

www.prlglass.com

SOLAR CONTROL LOW-E GLASS

Exceptional Line of High Performance Low-E Glass Inventory of Top Quality Products

Solar control glass is a product developed by the glass industry to allow sunlight to pass through a window while radiating and reflecting away a large degree of the sun's heat. Solar Control glass reduces solar heat gain and offers high levels of natural light to provide comfortable and pleasant environments in which to live and work. Low-E coated glass is one of the most popular and versatile types used today. We offer both Pyrolytic and MSVD coated Low-E Glass products that are adaptable to meet almost any glazing project and designer's energy efficiency requirements. Low-E coated glass plays an important part in the overall performance of the storefront, doors, windows, or curtain wall, and can significantly affect the overall heating, lighting, and the cooling cost of the building.

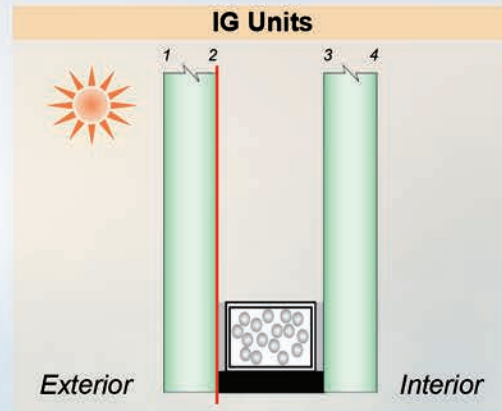
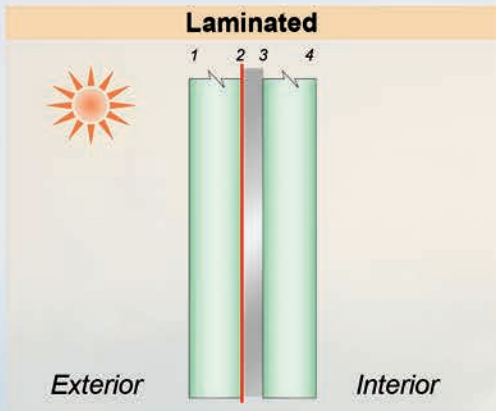

Resort Project with Low-E Glass IG Units

LOW E GLASS- Selection

CHARACTERISTICS:

- High visible light transmittance
- Low-to-medium reflectivity
- Excellent solar control
- Dramatic energy savings that meet or exceed local and regional building energy codes
- Fastest Low-E Glass Leadtimes in the industry
 - Next day service available

**Please consult PRL for availability, sizes, performance data and technical limitations.*

PYROLYTIC (HARD COATS)

1/8" (3.2mm), 3/16" (5mm), 1/4" (6mm)

Solarban® Energy Advantage

SOFT COATS

3/16" (5mm),

Solarban® 60

Solarban® 70

Solarban® 90

MSVD (SOFT COATS)

1/4" (6mm)

Solarban® 60

Super Neutral 68 HT Clr

Super Neutral 68 Clr Ann

Super Neutral 68 HT UltraClear

Super Neutral SNX 62/27 HT Clr

Super Neutral SNX 62/27 Clr Ann

Super Neutral 54 HT Crystal Gray

Super Neutral 54 HT Clear

Super Neutral SNX 51/23 HT Clr

SunGuard IS 20 HT Clr

SunGuard SNR 43



We also offer:

- Unlimited Glass Combinations
- Storefronts & Curtainwalls
- Architectural Break Formed Metals

TEXTURED GLASS

Ideal for Interior Decorative Options

Some Suitable Applications are:

- Shower Doors
- Handrails Systems
- Laminated Make-ups
- Wall Cover-ups
- Infill Panels

Note: Samples shown are for illustration purposes only, color/designs may vary from actual samples. Please consult PRL for details and availability.



Laminated 1/4" Reeded Tempered 060 SGP/ 1/4" Clear Tempered Glass



DELTA FROST
5/32"



DELTA CLEAR
5/32"



RAIN
3/16", 1/4", 3/8"



P-516
1/8", 5/32", 3/16", 1/4"



CLEAR GLUECHIP
3/16", 1/4",
3/8", 1/2"



REEDED
(1/2" space apart)
3/16", 1/4"

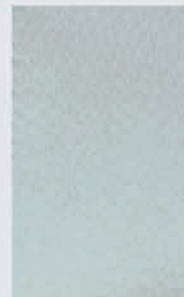

AQUATEX
3/16"



CROSSREED
(1/2" squares)
3/16"



BAMBOO
3/16", 3/8"



BAMBOO FROST
3/16"



MISCO WIRE
1/4"

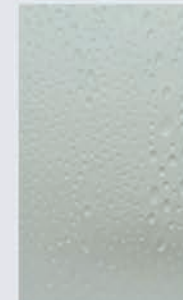

BUBBLE
1/4"



ACID ETCH
1/4", 3/8", 1/2"
(Low Iron- 1/4", 3/8", 1/2")



WATER FLEMISH
1/4"

PRL GLASS SYSTEMS

(800) 433-7044

www.prlglass.com

TEXTURED GLASS- for Shower Glass



Neo Angle Shower Unit with Rain Textured Glass

When discrete privacy is required on shower and steam units, textured glass is the perfect glass solution.

Various glass thickness from 5/16" to 3/8" glass patterns available to choose from in stock.

Note: Samples shown are for illustration purposes only, color/designs may vary from actual samples. Please consult PRL for details and availability.



SANDBLASTED
3/8", 1/2"



ACID ETCH/MATTE
3/8", 1/2"



BAMBOO
3/8"



GLUECHIP
3/8", 1/2"



RAIN
3/8"



CUSTOM GLUECHIP
SB DESIGN



Frameless Shower Slider with Acid Etch Glass

TINTED UNCOATED GLASS

Improved Performance Reducing the Amount of Sunlight Entering a Room



Features:

- Versatile range of tints
- Lower solar heat loads.
- Provide higher levels of natural daylight
- 1/4" or in other thicknesses*

Please check for other types of glass and performance data information available on pages 12 to 17.

Note: Samples shown are for illustration purposes only, colors may vary from actual glass samples. Performance data is available upon request. Please consult PRL for details and availability.

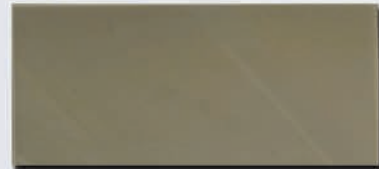

BRONZE

*1/8", 3/16", 1/4", 3/8" & 1/2"



SOLEXIA®

1/8", 3/16", 1/4"



AZURIA®

1/4"



GRAY

*1/8", 3/16", 1/4", 3/8" & 1/2"

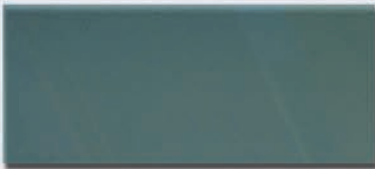

BLUE GREEN™

1/4", 3/8"

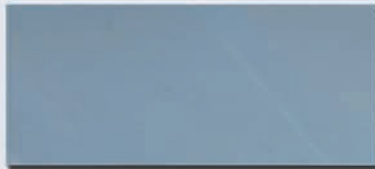

SOLARBLUE™

1/4"



GRAYLITE II®

1/8", 1/4"

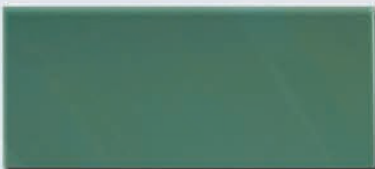

EVERGREEN / ATLANTICA®

1/4"



PACIFICA®

1/4"



SUPERGREY™

1/4"

All sheets size measure: 96" x 130"

REFLECTIVE GLASS

Extensive Color Palette & Performance Options with Exterior Visible Reflectivity & Metallic Sheen



Features:

- Improves solar control
- Limits the amount of sun damaging ultraviolet rays and heat to enter
- Available in 1/4" only unless otherwise noted below

Please check for other types of glass and performance data information available on pages 12 to 17.

Note: Samples shown are for illustration purposes only, colors may vary from actual samples. Performance data is available upon request. Please consult PRL for details and availability.

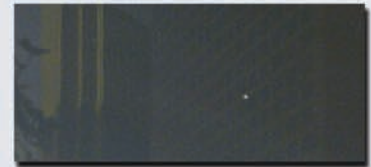

SOLARCOOL SOLARGRAY®

1/4"

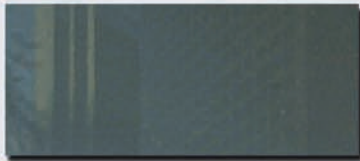

SOLARCOOL AZURIA®

1/4"

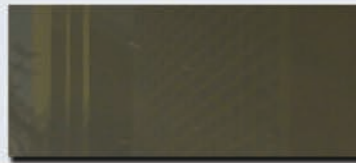

BRONZE ECLIPSE ADVANTAGE™

1/4"

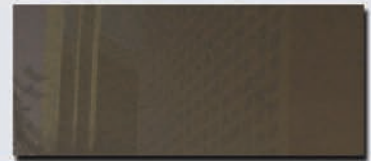

SOLARCOOL SOLARBRONZE®

1/4"

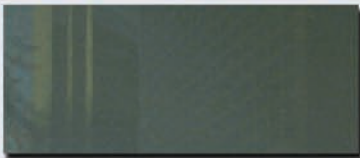

SOLARCOOL SOLARBLUE®

1/4"

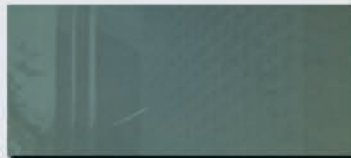

BLUEGREEN ECLIPSE ADVANTAGE™

1/4"

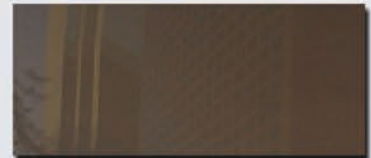

MIRROPANE™

1/4"

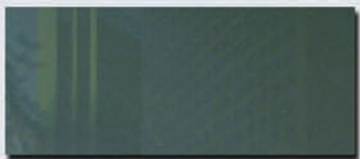

SOLARCOOL PACIFICA®

1/4"

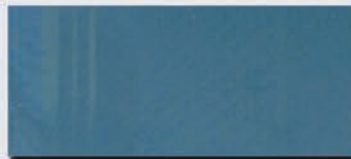

VISTACOO PACIFICA®

1/4"

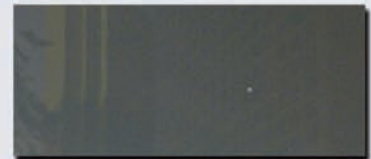

MIRROVIEW™

1/4"

All sheet size measures: 96" x 130"

PERFORMANCE DATA- Vitro® Monolithic Glass



Table of Performance Values*1

Glass Thickness		Visible Light Transmittance (VLT) ²	Visible Light Reflectance ²		(BTU/hr ² ft ² °F) NFRC U-Value ³		Solar Heat Gain Coefficient (SHGC) ⁴	Light-to-Solar Gain (LSG) ⁵	
Inches	mm		Exterior %	Interior %	Winter Night-time	Winter Argon			
Uncoated									
CLEAR Glass									
	1/8	3	90	9	9	1.04	na	0.86	1.05
	5/32	4	90	9	9	1.04	na	0.84	1.07
	3/16	5	89	9	9	1.03	na	0.83	1.07
	1/4	6	89	8	9	1.02	na	0.82	1.09
	5/16	8	87	8	9	1.01	na	0.79	1.10
	3/8	10	87	8	8	1.00	na	0.77	1.13
	1/2	12	85	8	8	0.98	na	0.73	1.16
	5/8	16	84	8	8	0.97	na	0.70	1.20
	3/4	19	83	8	8	0.95	na	0.67	1.24
STARPHIRE® Glass									
	1/8	3	91	8	8	1.04	na	0.91	1.00
	5/32	4	91	8	8	1.04	na	0.91	1.00
	3/16	5	91	8	8	1.03	na	0.90	1.01
	1/4	6	91	8	8	1.02	na	0.90	1.01
	5/16	8	91	8	8	1.01	na	0.89	1.02
	3/8	10	91	8	8	1.00	na	0.89	1.02
	1/2	12	90	8	8	0.98	na	0.88	1.02
	5/8	16	90	8	8	0.97	na	0.87	1.03
	3/4	19	90	8	8	0.95	na	0.86	1.05
SOLEXIA® Glass									
	1/8	3	83	8	8	1.04	na	0.70	1.19
	5/32	4	81	8	8	1.04	na	0.68	1.19
	3/16	5	79	8	8	1.03	na	0.65	1.22
	1/4	6	77	8	8	1.02	na	0.62	1.24
ATLANTICA® Glass									
	1/4	6	67	7	7	1.02	na	0.53	1.26
AZURIA® Glass									
	5/32	4	75	7	7	1.04	na	0.57	1.32
	3/16	5	72	7	7	1.03	na	0.54	1.33
	1/4	6	68	7	7	1.02	na	0.52	1.31
	5/16	8	61	6	6	1.01	na	0.48	1.27
	3/8	10	57	6	6	1.00	na	0.46	1.24
SOLARBLUE® Glass									
	1/4	6	56	6	6	1.02	na	0.61	0.92
PACIFICA® Glass									
	1/4	6	42	5	5	1.02	na	0.49	0.86
SOLARBRONZE® Glass									
	1/8	3	67	7	7	1.04	na	0.73	0.92
	5/32	4	63	7	7	1.04	na	0.70	0.90
	3/16	5	58	6	6	1.03	na	0.67	0.87
	1/4	6	53	6	6	1.02	na	0.63	0.84
	5/16	8	43	6	6	1.01	na	0.57	0.75
	3/8	10	37	5	6	1.00	na	0.53	0.70
	1/2	12	27	5	5	0.98	na	0.47	0.57
OPTIGRAY® Glass									
	1/4	6	63	6	6	1.02	na	0.64	0.98
SOLARGRAY® Glass									
	1/8	3	60	6	7	1.04	na	0.69	0.87
	5/32	4	56	6	7	1.04	na	0.66	0.85
	3/16	5	50	6	6	1.03	na	0.62	0.81
	1/4	6	44	6	6	1.02	na	0.58	0.76
	5/16	8	33	5	6	1.01	na	0.51	0.65
	3/8	10	28	5	5	1.00	na	0.48	0.58
	1/2	12	18	5	5	0.98	na	0.42	0.43

All glass above is available at PRL to fabricate to your specification!



Note: All information provided is deemed reliable, we recommend to independently verify the manufacturer data sheets for any product changes. Please consult us for details.

(800) 433-7044

www.prlglass.com

PERFORMANCE DATA- Vitro® Monolithic Glass

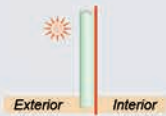

Table of Performance Values*1

Glass Thickness		Visible Light Transmittance (VLT) ²	Visible Light Reflectance ²		(BTU/hr·ft ² ·°F) NFRC U-Value ³		Solar Heat Gain Coefficient (SHGC) ⁴	Light-to-Solar Gain (LSG) ⁵	
Inches	mm		Exterior %	Interior %	Winter Night-time	Winter Argon			
Uncoated									
GRAYLITE® II Glass									
1/8	3	24	5	5	1.04	na	0.45	0.53	
5/32	4	18	4	5	1.04	na	0.41	0.44	
3/16	5	13	4	5	1.03	na	0.39	0.33	
1/4	6	9	4	5	1.02	na	0.36	0.25	
Coated									
VISTACOOL® (2) AZURIA® Glass									
1/4	6	52	19	29	1.02	na	0.46	1.13	
VISTACOOL® (2) PACIFICA® Glass									
1/4	6	32	10	28	1.02	na	0.44	0.73	
SOLARCOOL® (2) AZURIA® Glass									
3/16	5	27	20	36	1.04	na	0.39	0.69	
1/4	6	26	19	36	1.03	na	0.38	0.68	
SOLARCOOL® (1) AZURIA® Glass									
3/16	5	27	36	20	1.03	na	0.32	0.84	
1/4	6	26	36	19	1.03	na	0.31	0.84	
SOLARCOOL® (2) SOLARBLUE® Glass									
1/4	6	21	14	36	1.02	na	0.45	0.47	
SOLARCOOL® (1) SOLARBLUE® Glass									
1/4	6	21	36	14	1.02	na	0.38	0.55	
SOLARCOOL® (2) PACIFICA® Glass									
1/4	6	16	10	36	1.02	na	0.38	0.42	
SOLARCOOL® (1) PACIFICA® Glass									
1/4	6	16	36	10	1.02	na	0.31	0.52	
SOLARCOOL® (2) SOLARBRONZE® Glass									
1/4	6	21	13	36	1.03	na	0.47	0.45	
SOLARCOOL® (1) SOLARBRONZE® Glass									
1/4	6	21	36	13	1.03	na	0.40	0.53	
SOLARCOOL® (2) SOLARGRAY® Glass									
1/4	6	17	11	36	1.03	na	0.44	0.39	
SOLARCOOL® (1) SOLARGRAY® Glass									
1/4	6	17	36	11	1.03	na	0.37	0.46	

All glass above is available at PRL to fabricate to your specification!

1. Data is based on center of glass performance of representative factory production samples. Actual values may vary due to the production process and manufacturing tolerances. All tabulated data is based on NFRC methodology using the LBNL Window 7.3 software.
2. Transmittance and reflectance values based on spectrophotometric measurements and energy distribution of solar radiation.
3. U-Value – A measure of the insulating characteristics of the glass or how much heat gain or loss occurs through the glass due to the difference between indoor and outdoor temperatures and is measured Btu/hr·ft²·F. The lower the number, the better the insulating performance. This number is the reciprocal of the r-value. Winter argon represents the winter night-time u-value performance when the cavity is filled with a 90% argon/10% air/gas mixture.
4. Solar Heat Gain Coefficient (SHGC) – Measures how well a window blocks (or shades) the heat from sunlight. SHGC is the fraction of solar radiation transmitted through a window or skylight, as well as the amount that is absorbed by the glass and reradiated to the interior. SHGC is expressed as a number between 0 and 1. The lower a window's SHGC, the less solar heat it transmits and the greater the shading ability. The SHGC is similar to the Shading Coefficient (SC), but also accounts for absorbed, converted and inwardly radiated solar energy.
5. Light-to-solar gain (LSG) ratio is the ratio of visible light transmittance to solar heat gain coefficient.



Note: All information provided is deemed reliable, we recommend to independently verify the manufacturer data sheets for any product changes. Please consult us for details.

(800) 433-7044

www.prlglass.com

PERFORMANCE DATA- Vitro® 1-inch Insulating Glass Unit

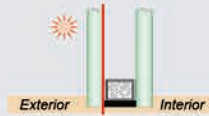

Insulating Glass Unit Performance Comparisons 1-inch (25mm) units with 1/2-inch (13mm) airspace and two 1/4-inch (6mm) lites

Outdoor Lite: Coating if Any (Surface) Glass	Glass Type +	Indoor Lite: Coating if Any (Surface) Glass	Visible Light Transmittance (VLT) ²	Visible Light Reflectance ²		(BTU/hr·ft ² ·°F) NFRC U-Value ³		Solar Heat Gain Coefficient (SHGC) ⁴	Light-to-Solar Gain (LSG) ⁵
					Interior %	Winter Night-time	Winter Argon		
Uncoated									
	CLEAR Glass + Clear		79	15	15	0.47	0.45	0.70	1.13
	STARPHIRE® + STARPHIRE		84	15	15	0.47	0.45	0.82	1.02
	SOLEXIA®+ Clear		69	13	15	0.47	0.45	0.50	1.38
	ATLANTICA®+ Clear		60	11	14	0.47	0.45	0.41	1.46
	AZURIA®+ Clear		61	11	14	0.47	0.45	0.39	1.56
	SOLARBLUE®+ Clear		50	9	13	0.47	0.45	0.49	1.02
	PACIFICA®+ Clear		38	7	13	0.47	0.45	0.36	1.06
	SOLARBRONZE®+ Clear		47	8	13	0.47	0.45	0.51	0.92
	OPTIGRAY®+ Clear		56	10	13	0.47	0.45	0.52	1.08
	SOLARGRAY®+ Clear		40	7	13	0.47	0.45	0.46	0.87
	GRAYLITE® II + Clear		8	4	12	0.47	0.45	0.22	0.36
Coated									

SUNGATE® 400 Low-E Glass

	SUNGATE 400 (2) Clear + Clear		76	14	14	0.32	0.28	0.60	1.27
	SUNGATE 400 (2) STARPHIRE + STARPHIRE		80	14	14	0.32	0.28	0.68	1.18
	CLEAR + SUNGATE 400 (3) Clear		76	14	14	0.32	0.28	0.63	1.21
	SOLEXIA + SUNGATE 400 (3) Clear		66	11	13	0.32	0.28	0.44	1.50
	ATLANTICA + SUNGATE 400 (3) Clear		58	10	12	0.32	0.28	0.35	1.66
	AZURIA + SUNGATE 400 (3) Clear		59	10	12	0.32	0.28	0.34	1.74
	SOLARBLUE + SUNGATE 400 (3) Clear		48	8	12	0.32	0.28	0.42	1.14
	PACIFICA + SUNGATE 400 (3) Clear		37	7	11	0.32	0.28	0.30	1.23
	SOLARBRONZE + SUNGATE 400 (3) Clear		46	8	12	0.32	0.28	0.44	1.05
	OPTIGRAY + SUNGATE 400 (3) Clear		54	9	12	0.32	0.28	0.46	1.17
	SOLARGRAY + SUNGATE 400 (3) Clear		38	7	12	0.32	0.28	0.39	0.97
	GRAYLITE II + SUNGATE 400 (3) Clear		8	4	11	0.32	0.28	0.15	0.53

SOLARBAN® 60 Solar Control Low-E Glass

	SOLARBAN 60 (2) Clear + Clear		70	11	12	0.29	0.24	0.39	1.79
	SOLARBAN 60 (2) STARPHIRE + STARPHIRE		74	11	12	0.29	0.24	0.41	1.80
	SOLARBAN 60 (2) SOLEXIA + Clear		61	9	12	0.29	0.24	0.32	1.91
	SOLARBAN 60 (2) ATLANTICA + Clear		53	8	11	0.29	0.24	0.27	1.96
	SOLARBAN 60 (2) AZURIA + Clear		54	8	11	0.29	0.24	0.28	1.93
	SOLARBAN 60 (2) SOLARBLUE + Clear		45	7	11	0.29	0.24	0.28	1.61
	SOLARBAN 60 (2) PACIFICA + Clear		34	6	10	0.29	0.24	0.22	1.55
	SOLARBAN 60 (2) SOLARBRONZE + Clear		42	7	11	0.29	0.24	0.28	1.50
	SOLARBAN 60 (2) OPTIGRAY + Clear		50	8	11	0.29	0.24	0.30	1.67
	SOLARBAN 60 (2) SOLARGRAY + Clear		35	6	10	0.29	0.24	0.25	1.40
	SOLEXIA + SOLARBAN 60 (3) Clear		61	10	10	0.29	0.24	0.37	1.65
	ATLANTICA + SOLARBAN 60 (3) Clear		53	9	10	0.29	0.24	0.31	1.71
	AZURIA + SOLARBAN 60 (3) Clear		54	9	10	0.29	0.24	0.31	1.74
	SOLARBLUE + SOLARBAN 60 (3) Clear		45	7	9	0.29	0.24	0.33	1.36
	PACIFICA + SOLARBAN 60 (3) Clear		34	6	9	0.29	0.24	0.25	1.36
	SOLARBRONZE + SOLARBAN 60 (3) Clear		42	7	9	0.29	0.24	0.32	1.31
	OPTIGRAY + SOLARBAN 60 (3) Clear		50	8	9	0.29	0.24	0.35	1.43
	SOLARGRAY + SOLARBAN 60 (3) Clear		35	7	9	0.29	0.24	0.29	1.21
	GRAYLITE II + SOLARBAN 60 (3) Clear		7	4	8	0.29	0.24	0.13	0.54

All glass above is available at PRL to fabricate to your specification!



Note: All information provided is deemed reliable, we recommend to independently verify the manufacturer data sheets for any product changes. Please consult us for details.

(800) 433-7044

www.prlglass.com

PERFORMANCE DATA- Vitro® 1-inch Insulating Glass Unit

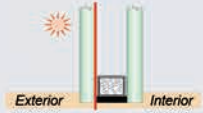

Insulating Glass Unit Performance Comparisons 1-inch (25mm) units with 1/2-inch (13mm) airspace and two 1/4-inch (6mm) lites

Outdoor Lite: Coating if Any (Surface) Glass	+	Indoor Lite: Coating if Any (Surface) Glass	Visible Light Transmittance (VLT) ²	Visible Light Reflectance ²		(BTU/hr ² ft ² °F) NFRC U-Value ³		Solar Heat Gain Coefficient (SHGC) ⁴	Light-to-Solar Gain (LSG) ⁵
				Exterior %	Interior %	Winter Night-time	Winter Argon		
Uncoated									
VISTACOOl® Subtly Reflective Glass									
VISTACOOl (2) AZURIA + Clear			47	21	32	0.47	0.45	0.34	1.38
VISTACOOl (2) PACIFICA + Clear			29	11	31	0.47	0.45	0.32	0.91
SOLARCOOl® Reflective Glass									
SOLARCOOl (2) AZURIA + Clear			24	20	38	0.47	0.45	0.25	0.96
SOLARCOOl (2) PACIFICA + Clear			15	10	38	0.47	0.45	0.25	0.60
SOLARCOOl (2) SOLARBLUE + Clear			20	15	38	0.47	0.45	0.32	0.63
SOLARCOOl (2) SOLARBRONZE + Clear			19	14	38	0.47	0.45	0.34	0.56
SOLARCOOl (2) SOLARGRAY + Clear			16	11	38	0.47	0.45	0.32	0.50
VISTACOOl® and SOLARCOOl® with SOLARBAN® 60 Solar Control Low-E (3)									
VISTACOOl (2) AZURIA + SOLARBAN 60 (3) Clear			42	20	24	0.29	0.24	0.26	1.62
VISTACOOl (2) PACIFICA + SOLARBAN 60 (3) Clear			26	11	23	0.29	0.24	0.21	1.24
SOLARCOOl (2) AZURIA + SOLARBAN 60 (3) Clear			21	19	29	0.29	0.24	0.17	1.24
SOLARCOOl (2) SOLARBLUE + SOLARBAN 60 (3) Clear			17	14	29	0.29	0.24	0.18	0.94
SOLARCOOl (2) PACIFICA + SOLARBAN 60 (3) Clear			13	10	29	0.29	0.24	0.15	0.87
SOLARCOOl (2) SOLARBRONZE + SOLARBAN 60 (3) Clear			17	14	29	0.29	0.24	0.18	0.94
SOLARCOOl (2) SOLARGRAY + SOLARBAN 60 (3) Clear			14	11	29	0.29	0.24	0.17	0.82

All glass above is available at PRL to fabricate to your specification!

1. Data is based on center of glass performance of representative factory production samples. Actual values may vary due to the production process and manufacturing tolerances. All tabulated data is based on NFRC methodology using the LBNL Window 7.3 software.
2. Transmittance and Reflectance values based on spectrophotometric measurements and energy distribution of solar radiation.
3. U-Value – A measure of the insulating characteristics of the glass or how much heat gain or loss occurs through the glass due to the difference between indoor and outdoor temperatures and is measured Btu/hr·ft²·°F. The lower the number, the better the insulating performance. This number is the reciprocal of the R-value. Winter argon represents the winter night-time u-value performance when the cavity is filled with a 90% argon/10% air/gas mixture.
4. Solar Heat Gain Coefficient (SHGC) – Measures how well a window blocks (or shades) the heat from sunlight. SHGC is the fraction of solar radiation transmitted through a window or skylight, as well as the amount that is absorbed by the glass and reradiated to the interior. SHGC is expressed as a number between 0 and 1. The lower a window's SHGC, the less solar heat it transmits and the greater the shading ability. The SHGC is similar to the Shading Coefficient (SC), but also accounts for absorbed, converted and inwardly radiated solar energy.
5. Light-to-solar gain (LSG) ratio is the ratio of visible light transmittance to solar heat gain coefficient. Ultraviolet Energy (UV) – The percentage of incident ultraviolet energy that is directly transmitted through the glass. Long-term exposure to UV light may result in fabric and pigment fading, plastic deterioration and changes to the appearance of many types of carpet and wood.

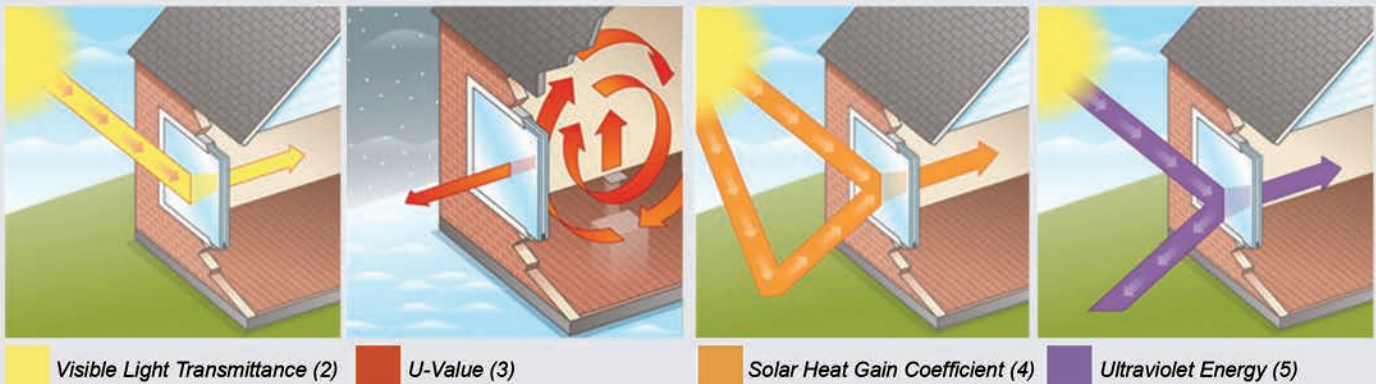

Visible Light Transmittance (2)

U-Value (3)

Solar Heat Gain Coefficient (4)

Ultraviolet Energy (5)



Note: All information provided is deemed reliable, we recommend to independently verify the manufacturer data sheets for any product changes. Please consult us for details.

(800) 433-7044

www.prlglass.com

PERFORMANCE DATA- Guardian® Glass

SUNGUARD® Advanced Architectural Glass

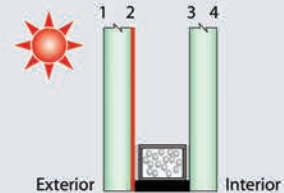

PERFORMANCE DATA – SUPERNEUTRAL

Product	Outboard - Inboard Substrate	Appearance	Transmittance			Reflectance			U-Value Winter Nighttime		Relative Heat Gain	Solar Heat Gain Coefficient	Light to Solar Gain (LSG)
			Visible Light %	Ultra-violet %	Solar Energy %	Visible Light Out %	Visible Light In %	Solar Energy Out %	Air	Argon			
SunGuard SuperNeutral			Coating #2 Surface						6 mm/12.7 mm a.s./6 mm				
SNX 62/27	UltraClear - UltraClear	Ultra Clear	64	8	24	11	13	51	0.29	0.24	65	0.27	2.40
	Clear - Clear	Clear	62	6	23	11	12	39	0.29	0.24	65	0.27	2.31
	Green - Clear	Green	52	3	18	9	12	10	0.29	0.24	59	0.24	2.13
	CrystalGray - Clear	Light Gray	44	3	16	8	11	19	0.29	0.24	54	0.22	1.98
	Gray - Clear	Gray	31	3	12	6	11	19	0.29	0.24	45	0.18	1.71
	CrystalBlue - Clear	Blue	40	4	15	7	11	25	0.29	0.24	51	0.21	1.91
SNX 51/23	UltraClear - UltraClear	Light Blue	53	14	20	14	14	46	0.29	0.24	57	0.23	2.28
	Clear - Clear	Light Blue	51	11	19	14	14	36	0.29	0.24	57	0.23	2.19
	Green - Clear	Blue-Green	43	5	15	11	13	10	0.29	0.24	52	0.22	1.99
	CrystalGray - Clear	Light Gray	36	6	14	9	13	18	0.29	0.24	48	0.20	1.85
	Gray - Clear	Gray	26	5	10	7	13	17	0.29	0.24	41	0.16	1.57
	CrystalBlue - Clear	Blue	33	7	13	9	13	23	0.29	0.24	46	0.19	1.78
SN 68	UltraClear - UltraClear	Ultra Clear	71	40	37	11	13	43	0.29	0.25	94	0.39	1.80
	Clear - Clear	Clear	68	30	33	11	12	33	0.29	0.25	90	0.38	1.80
	Green - Clear	Green	57	13	23	9	12	9	0.29	0.25	72	0.30	1.92
	CrystalGray - Clear	Light Gray	48	17	23	8	11	16	0.29	0.25	71	0.30	1.64
	Gray - Clear	Gray	34	13	18	6	11	16	0.29	0.25	61	0.25	1.37
	CrystalBlue - Clear	Blue	44	19	23	7	11	21	0.29	0.25	70	0.29	1.51
SN 54	UltraClear - UltraClear	Ultra Clear	56	22	26	13	19	44	0.29	0.24	69	0.29	1.96
	Clear - Clear	Clear	54	16	24	13	18	35	0.29	0.24	68	0.28	1.92
	Green - Clear	Green	45	7	17	11	18	10	0.29	0.24	58	0.24	1.89
	CrystalGray - Clear	Light Gray	38	9	17	9	18	17	0.29	0.24	56	0.23	1.67
	Gray - Clear	Gray	27	7	13	7	17	16	0.29	0.24	48	0.19	1.40
	CrystalBlue - Clear	Blue	35	10	16	8	17	22	0.29	0.24	54	0.22	1.57
SNR 43	UltraClear - UltraClear	Light Silver	45	24	21	28	14	54	0.29	0.24	56	0.23	1.96
	Clear - Clear	Light Silver	43	17	19	28	14	43	0.29	0.24	56	0.23	1.89
	Green - Clear	Green	36	8	14	21	14	14	0.29	0.24	50	0.20	1.78
	CrystalGray - Clear	Silver Gray	31	9	13	16	14	21	0.29	0.24	47	0.19	1.59
	Gray - Clear	Silver Gray	22	8	10	10	13	19	0.29	0.24	41	0.17	1.31
	CrystalBlue - Clear	Silver Blue	28	11	13	14	13	26	0.29	0.24	46	0.19	1.50

All glass above is available at PRL to fabricate to your specification!

NOTES RELATED TO ALL SUNGUARD PERFORMANCE TABLES:

- The performance values shown are nominal and subject to variations due to manufacturing tolerances.
- All coatings are on the #2 surface unless noted otherwise.
- Guardian performance data are calculated for center-of-glass only (no spacer or framing) in accordance with the LBNL Window 7 program.
- Relative Heat Gain, Solar Heat Gain Coefficient and/or LSG may change slightly when using argon gas fill.
- Glass may require heat strengthening or tempering to resist potential thermal stresses. SNR 43 must be heat-treated.
- A slight shift in visible light reflectance or transmission may be noticed after heat-treatment.
- Guardian recommends edge deletion for all commercial low-E coatings.
- Guardian Glass reserves the right to change product performance characteristics without notice or obligation.



Note: All information provided is deemed reliable, we recommend to independently verify the manufacturer data sheets for any product changes. Please consult us for details.

(800) 433-7044

www.prlglass.com

PERFORMANCE DATA- Guardian® Glass

SUNGUARD®

Advanced Architectural Glass

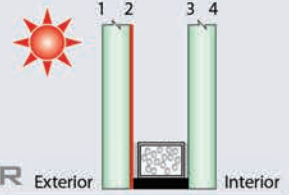

PERFORMANCE DATA – HIGH PERFORMANCE & SOLAR

Product	Outboard - Inboard Substrate	Appearance	Transmittance			Reflectance			U-Value Winter Nighttime		Relative Heat Gain	Solar Heat Gain Coefficient	Light to Solar Gain (LSG)
			Visible Light %	Ultra-violet %	Solar Energy %	Visible Light Out %	Visible Light In %	Solar Energy Out %	Air	Argon			
SunGuard High Performance													
Coating #2 Surface - except where noted (#3) 6 mm/12.7 mm a.s./6 mm													
Neutral 78/65 (#3)	UltraClear - UltraClear	Ultra Clear	81	54	66	13	13	23	0.31	0.27	171	0.72	1.12
	Clear - Clear	Clear	78	39	55	13	13	19	0.31	0.27	156	0.66	1.18
Neutral 78/65	UltraClear - UltraClear	Ultra Clear	81	54	66	13	13	22	0.31	0.27	160	0.68	1.19
	Clear - Clear	Clear	78	39	55	13	13	18	0.31	0.27	147	0.62	1.26
Neutral 50	Clear - Clear	Neutral Blue	50	31	32	16	11	20	0.33	0.29	95	0.39	1.27
	Green - Clear	Green	42	13	20	13	10	9	0.33	0.29	68	0.28	1.50
Neutral 40	Clear - Clear	Neutral Gray	40	27	25	21	12	23	0.33	0.29	78	0.32	1.25
	Green - Clear	Green	34	11	16	16	12	10	0.33	0.29	59	0.24	1.40
AG 50	UltraClear - UltraClear	Light Silver	52	43	33	28	19	41	0.30	0.25	86	0.36	1.45
	Clear - Clear	Light Silver	50	30	29	27	19	34	0.30	0.25	82	0.34	1.48
	Green - Clear	Green	42	12	18	21	18	13	0.30	0.25	61	0.25	1.66
	CrystalGray - Clear	Silver Gray	35	16	20	16	18	18	0.30	0.25	64	0.26	1.34
	Gray - Clear	Silver Gray	25	12	16	10	18	16	0.30	0.25	57	0.23	1.08
AG 43	CrystalBlue - Clear	Silver Blue	32	17	20	14	18	21	0.30	0.25	65	0.27	1.20
	UltraClear - UltraClear	Light Silver	45	38	30	30	15	40	0.30	0.26	80	0.33	1.34
	Clear - Clear	Light Silver	43	26	26	30	15	33	0.30	0.26	76	0.31	1.37
	Green - Clear	Green	36	11	16	22	15	13	0.30	0.26	57	0.23	1.55
	CrystalGray - Clear	Silver Gray	30	14	18	17	14	18	0.30	0.26	60	0.25	1.23
SunGuard Solar	Clear - Clear	Silver	18	16	14	30	30	26	0.37	0.33	56	0.22	0.81
	Green - Clear	Silver Green	15	7	8	23	30	12	0.37	0.33	46	0.18	0.83

PERFORMANCE DATA WITH SUNGUARD IS 20

Product	Outboard - Inboard Substrate	Appearance	Transmittance			Reflectance			U-Value Winter Nighttime		Relative Heat Gain	Solar Heat Gain Coefficient	Light to Solar Gain (LSG)
			Visible Light %	Ultra-violet %	Solar Energy %	Visible Light Out %	Visible Light In %	Solar Energy Out %	Air	Argon			
SunGuard SuperNeutral + IS 20													
Coating #2 & IS 20 #4 Surface 6 mm/12.7 mm a.s./6 mm													
SNX 62/27 + IS 20	UltraClear - UltraClear	Ultra Clear	62	8	24	12	13	51	0.23	0.20	62	0.26	2.41
	Clear - Clear	Clear	60	6	22	12	13	40	0.23	0.20	62	0.26	2.33
SNX 51/23 + IS 20	UltraClear - UltraClear	Light Blue	51	13	20	14	14	46	0.23	0.20	54	0.22	2.31
	Clear - Clear	Light Blue	50	10	18	14	14	36	0.23	0.20	54	0.22	2.23
SN 68 + IS 20	UltraClear - UltraClear	Ultra Clear	69	37	36	12	13	43	0.24	0.20	91	0.38	1.80
	Clear - Clear	Clear	66	29	32	12	13	33	0.24	0.20	87	0.36	1.82
SN 54 + IS 20	UltraClear - UltraClear	Ultra Clear	54	20	25	14	19	44	0.24	0.20	67	0.28	1.97
	Clear - Clear	Clear	52	15	23	14	19	35	0.24	0.20	65	0.27	1.94
SNR 43 + IS 20	UltraClear - UltraClear	Light Silver	43	22	20	29	15	54	0.23	0.20	54	0.22	1.97
	Clear - Clear	Light Silver	42	17	18	28	15	43	0.23	0.20	53	0.22	1.92

All glass above is available at PRL to fabricate to your specification!

NOTES SPECIFIC TO THE SUNGUARD SUPERNEUTRAL w/IS 20 TABLE ABOVE:

- SunGuard IS 20 is on the #4 surface.
- SunGuard IS 20 is also available with SunGuard High Performance and Solar products.



Note: All information provided is deemed reliable, we recommend to independently verify the manufacturer data sheets for any product changes. Please consult us for details.

(800) 433-7044

www.prlglass.com

FIRE RESISTANT GLASS

Think Clear. Think Big. Think Keralite.

KERALITE® FILMED

Fire-Rated Safety Glass Ceramic

- 3/16" thick glass ceramic
- 20-90, 180 minute fire rating
- Installs into standard fire rated frames
- Protects from smoke & flames
- 88% visible Light transmission

KERALITE® LAMINATED

Fire-Rated Laminated Safety Glass Ceramic

- 5/16" thick glass ceramic
- 20-90, 180 minute fire rating
- Installs into standard fire rated frames
- Protects from smoke & flames
- 82% visible Light transmission



Fire Rated Glass Applications:

- Schools
- Healthcare Facilities
- Government Buildings
- Hospitality Projects



FIRE RESISTANT GLASS- Keralite® Features

The best in class glass ceramic features:

- The largest extended-size glass ceramic available
- Lowest haze
- Highest color rendering index
- Fastest in the industry
- Superior Customer Service



KERALITE®
Fire Rated Glass

Note: Samples shown are for illustration purposes only, colors may vary from actual samples. Performance data is available upon request. Please consult PRL for details and availability.



Entrance Door with Keralite Fire Rated Laminated Glass



Stadium Entrance System with Keralite Fire Rated IG Units

FIRE RESISTANT GLASS- *Filmed Features*

KERALITE® FILMED

Fire-Rated Safety Glass Ceramic

CLASSIFICATION



PRODUCT FEATURES

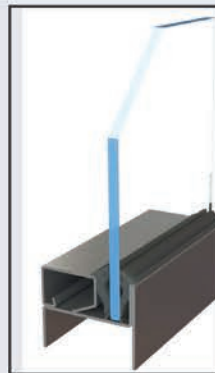

TECHNICAL SPECIFICATIONS

Fire Rating	20-90, 180 Minute
US Testing	Listed and labeled with Underwriters Laboratories Inc. File #R14515 Tested in accordance with UL 9, UL 10B, UL 10C, NFPA 80, NFPA 252, NFPA 257
Canadian Testing	CAN/ULC-S106, S104
Impact Safety Rating	CPSC 16CFR Part 1201 (CATEGORIES I & II), ANSI Z97.1, CAN/CGSB-12.1-M
Nominal Thickness	3/16" (5 mm)
Thickness Tolerance	+1/64" to -1/64" (+0.4 mm to -0.4 mm)
U value BTU/(hr*sqft*degF)	0.88
STC Rating	35
Weight (lbs/sq ft.)	2.4
Approx. Visible Light Transmission	86%

AUTHORIZED DIMENSIONS

RATING	WINDOW/TRANSOM/SIDELIGHT			DOOR - NON-TEMPERATURE RISE			DOOR - TEMPERATURE RISE		
	AREA (Max.)	WIDTH (Max.)	HEIGHT (Max.)	AREA (Max.)	WIDTH (Max.)	HEIGHT (Max.)	AREA (Max.)	WIDTH (Max.)	HEIGHT (Max.)
20	4,500	95-3/8	95-3/8	3,627	46-1/2	78	N/A		
45	4,500	95-3/8	95-3/8	3,627	46-1/2	78	N/A		
60	4,500	95-3/8	95-3/8	3,627	46-1/2	78	100	10	33
90	4,500	95-3/8	95-3/8	3,627	46-1/2	76	100	10	33
180	N/A			N/A			100	10	33

Maximum sheet size for this product is 46" x 96".
Height multiplied by width cannot exceed maximum exposed area.

Rev. 11.16 The information published in this document is correct at the time of going to press. Such information may be subject to change and products may be modified.



Note: All information provided is deemed reliable, we recommend to independently verify the manufacturer data sheets for any product changes. Please consult us for details.

(800) 433-7044

www.prlglass.com

FIRE RESISTANT GLASS- *Laminated Features*

KERALITE® LAMINATED

Fire-Rated Laminated Safety Glass Ceramic

CLASSIFICATION

PRODUCT FEATURES

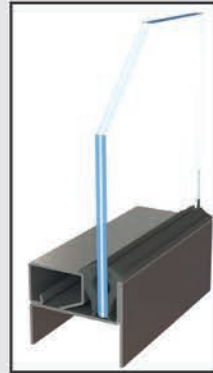

TECHNICAL SPECIFICATIONS

Fire Rating	20-90, 180 Minute
US Testing	Listed and labeled with Underwriters Laboratories Inc. File #R14515 Tested in accordance with UL 9, UL 10B, UL 10C, NFPA 80, NFPA 252, NFPA 257
Canadian Testing	CAN/ULC-S106, S104
Impact Safety Rating	CPSC 16CFR Part 1201 (CATEGORIES I & II). ANSI Z97.1, CAN/CGSB-12.1-M
Nominal Thickness	5/16" (8 mm)
Thickness Tolerance	+1/64" to -1/64" (+0.4 mm to -0.4 mm)
U value BTU/(hr*sqft*degF)	0.88
STC Rating	37
Weight (lbs/sq ft.)	4.1
Approx. Visible Light Transmission	82%

AUTHORIZED DIMENSIONS

RATING	WINDOW/TRANSOM/SIDELIGHT			DOOR - NON-TEMPERATURE RISE			DOOR -TEMPERATURE RISE		
	AREA (Max.)	WIDTH (Max.)	HEIGHT (Max.)	AREA (Max.)	WIDTH (Max.)	HEIGHT (Max.)	AREA (Max.)	WIDTH (Max.)	HEIGHT (Max.)
20	4,500	95-3/8	95-3/8	3,627	46-1/2	78	N/A		
45	4,500	95-3/8	95-3/8	3,627	46-1/2	78	N/A		
60	4,500	95-3/8	95-3/8	3,627	46-1/2	78	100	10	33
90	4,500	95-3/8	95-3/8	3,627	46-1/2	76	100	10	33
180	N/A			N/A			100	10	33

Maximum sheet size for this product is 44" x 96".
Height multiplied by width cannot exceed maximum exposed area.

Rev. 1.1.16 The information published in this document is correct at the time of going to press. Such information may be subject to change and products may be modified.



Note: All information provided is deemed reliable, we recommend to independently verify the manufacturer data sheets for any product changes. Please consult us for details.

(800) 433-7044

www.prlglass.com

HEAVY TEMPERED GLASS OUR SPECIALTY

Unlimited Glass Applications

PRL Tempering Oven Maximum Glass Sizes:

1. 110" x 198"
2. 96" x 172"
3. 84" x 184"
4. 60" x 120"



Oversize Fixed Panels with 3/4" Tempered Glass

PRL GLASS SYSTEMS

(800) 433-7044

www.prlglass.com

HEAVY TEMPERED GLASS- Features

Tempered glass is much more resistant to breakage than non-tempered glass. If the glass breaks, the glass disintegrates into relatively small pieces, which are less likely to cause serious injury. Our most common tempered glass applications are for entrance doors, storefront, railing, balconies, etc.

- Maximum Tempering Oven Glass Size 110" x 198"
- Convection Tempering System (specializes in Soft Coat Low-E)
- Tempers from 1/8" - 3/4"
- Superior Quality
- High production capability with 4 Tempering Ovens

**Consult PRL for Details*



Heavy Tempered Frameless Glass Storefront



Glass Wall System with Full Frame Entrance Doors

PRL GLASS SYSTEMS

(800) 433-7044

www.prlglass.com

HEAVY TEMPERED GLASS- Applications



TVS System with Tempered Sidelites & Spandrel Column Covers



Segmented P-Style Entrance System with PL-150DS Dryset Rails & Ladder Pulls

PRL GLASS SYSTEMS

(800) 433-7044

www.prlglass.com

HEAVY TEMPERED GLASS- Applications



Custom Sectional Handrail with Laminated/ Tempered Glass



Custom All Glass Entrance with Ladder Pulls

HEAVY TEMPERED GLASS- Applications



Custom All Glass Entrance with Ladder Pulls/ Handrail



All Tempered Glass Tiffany Slider with Ladder Pulls

HEAVY TEMPERED GLASS- Hole Fabrication

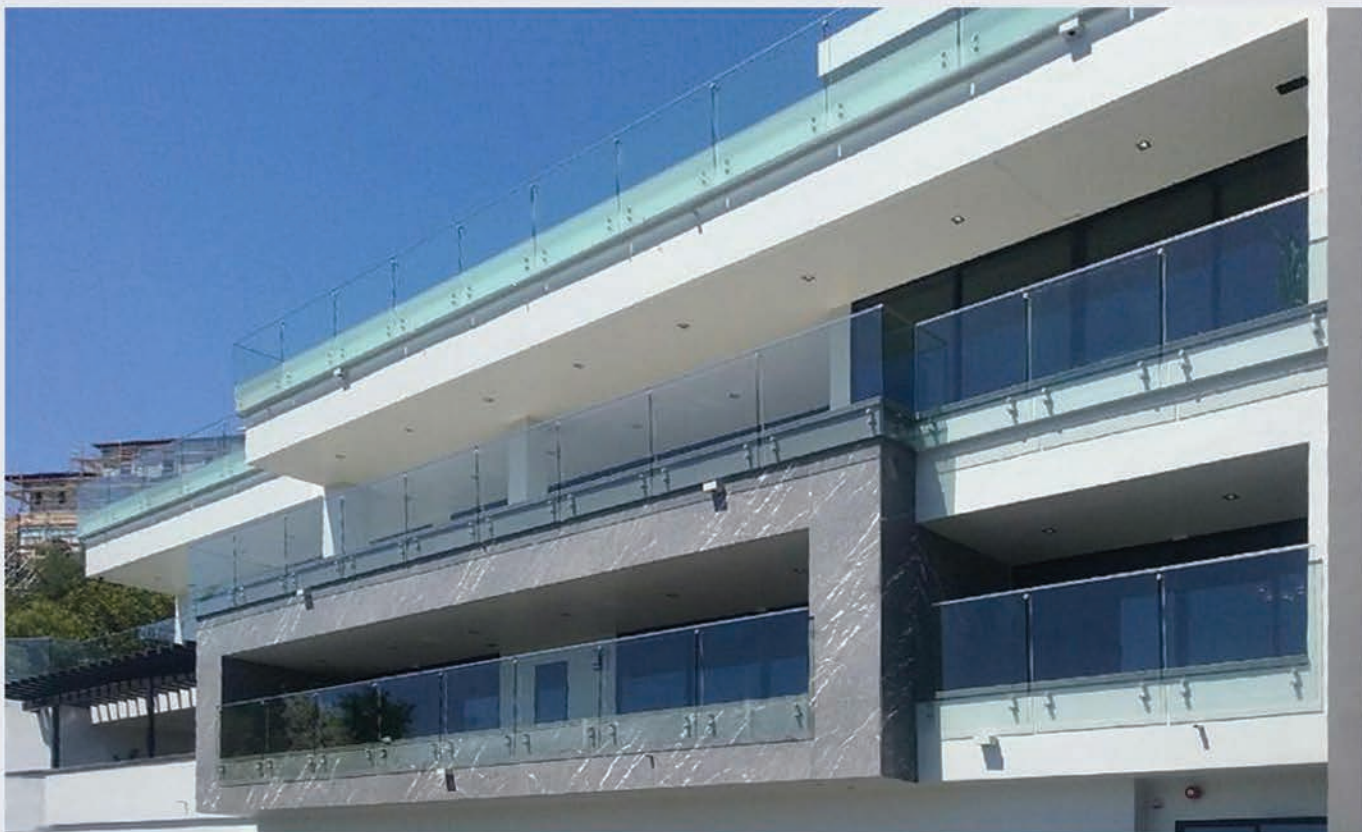

Handrail System with Tempered Laminated SentryGlas®



Glass Wall System with 3/4 Clear Tempered Glass

HOLE FABRICATION PRIOR TO TEMPERING

Glass Thickness: (A)	Min. Hole Size (Diameter) (B).	Minimum Distance from Edge (C)	Minimum 45 Diagonal Distance to Corner (D)
1/8"	1/8"	3/16"	7/8"
3/16"	3/16"	5/16"	1 1/4"
7/32"	7/32"	3/8"	1 7/16"
1/4"	1/4"	3/8"	1 5/8"
3/8"	3/8"	9/16"	2 7/16"
1/2"	1/2"	3/4"	3 1/4"
3/4"	3/4"	1 1/2"	4 7/8"

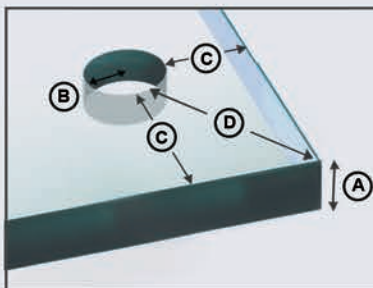

Glass cannot be tempered if the holes do not meet the minimum dimensions shown on the graph above.

If the holes are closer than dimension in chart, it can be tempered if relief cut is acceptable.

INSULATING GLASS UNITS

PRL I.G. Units are a High Quality, Total Energy Performance Product that Translates into Reduced Energy Cost and Increased Comfort.

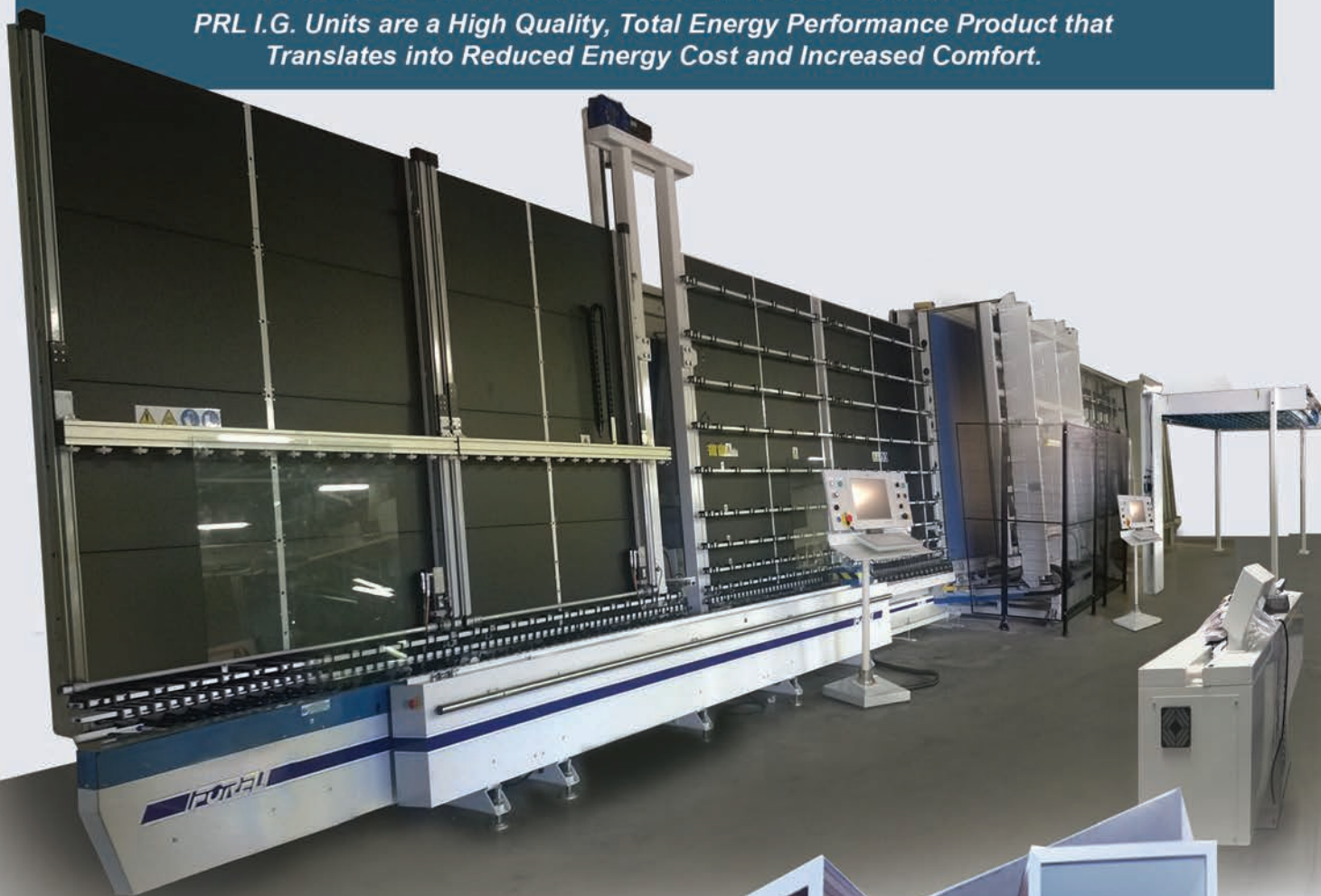

Insulating Glass Units are manufactured in TWO state of the art Vertical IG production lines to offer you the highest quality available in today's market.

PRL Insulating Glass Units can be composed of two or more sheets of float or coated glass. Providing heat or cold insulation, condensation and sound control.

IG Unit line capabilities

- Max. sizes 98" x 137"
- Min. size 6" x 6"
- Lead-times are 2 to 3 working days
- 24-hour service available upon request
- Thickness from 1/2" to 1 1/2"



PRL GLASS SYSTEMS

(800) 433-7044

www.prlglass.com

INSULATING GLASS UNITS- Features & Guidelines

PRL Insulating Glass(IG) Units or "double-pane" glass are used in residential, commercial and industrial construction. IG Units are required by building codes in many areas as a mandatory energy conservation measure. All our IG units are hermetically sealed combinations of two or more lites of glass separated by a dry airspace. IG units improve thermal performance, significantly reducing heating and air conditioning costs.

Total energy performance units features:

Dual seal Primary seal, butyl

Secondary seal, polysulfide / silicone

Argon gas-fill (optional)

3/16"-3/4" Aluminum spacer with integral desiccant

Unit thickness from 1/2" inches to 1 1/2" inches

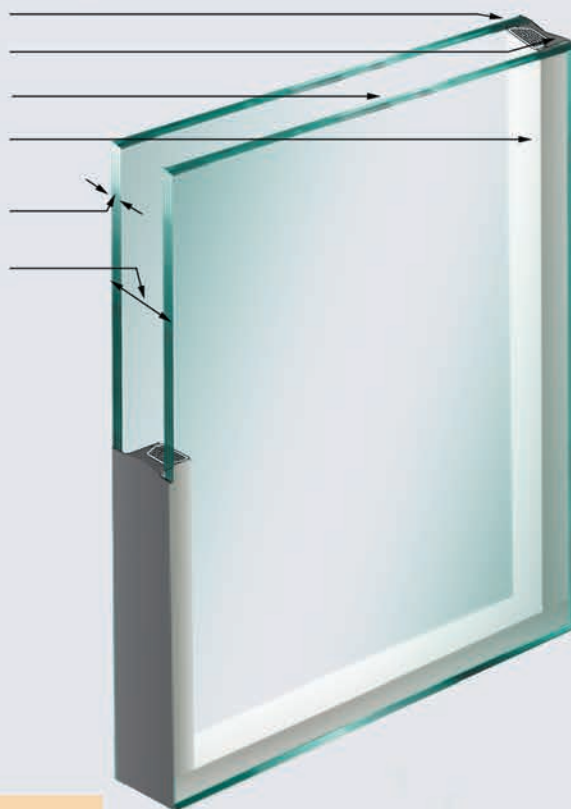

Applications

Insulating glass helps to maintain inside room temperature while saving energy- Residential or Commercial.

Insulating glass can also be used to assist in noise reduction. Insulated glass made with laminated glass offers excellent sound control.

IG SIZE CHART		
GLASS THICKNESS	AIR SPACER	MAX SQ FT
1/8" (DSB)	3/16"	9
	1/4"	14
	3/8" & up	18
3/16"	1/4"	25
	3/8" & up	30
1/4"	1/4"	30
	3/8"	35
	1/2"	50
	5/8"	60
	3/4"	65

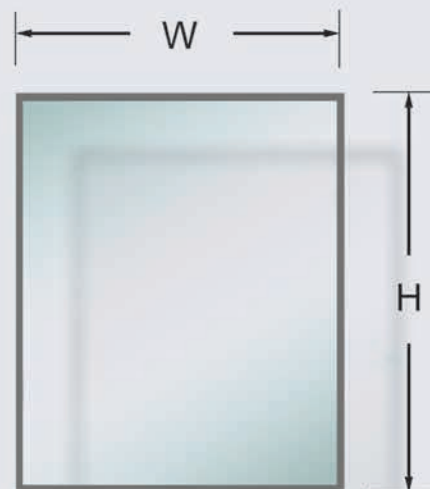

All Units over 50 sq ft must be tempered. All units over these guidelines will not be warranted and must be approved on a case by case basis.

INSULATING GLASS UNITS- Spacers & Grids

- Standard Spacers available in 3/16" - 3/4" in either clear or bronze
- Standard Grids (5/8" & 3/4" in either white or bronze)
- Sculptured grids available (5/16" x 1" White)
- Eneredge Spacers in 3/16" grey, 3/8" and 1/2" grey or black



Grids



Shapes

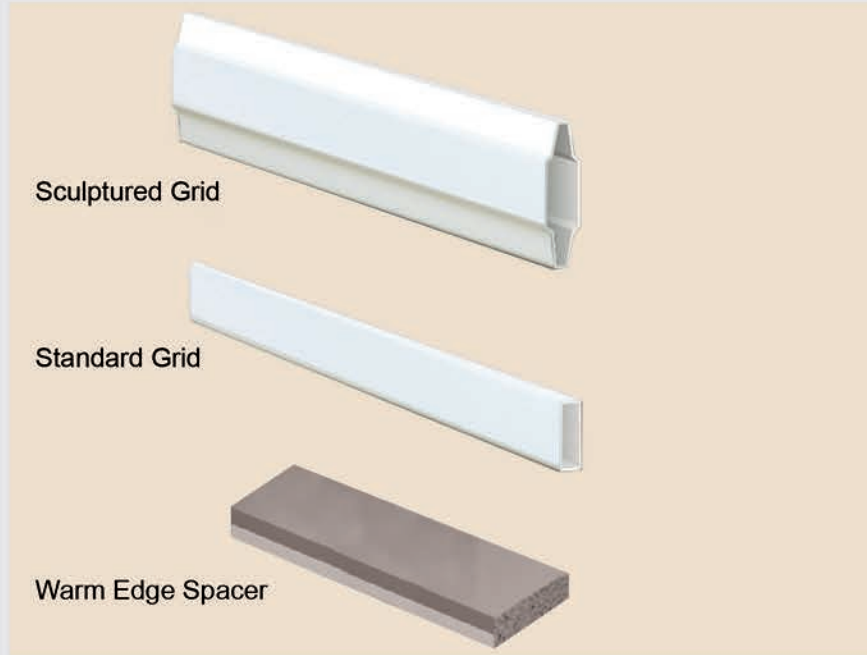

Sculptured Grid

Standard Grid

Warm Edge Spacer

100%
Exterior
Energy
Transmission

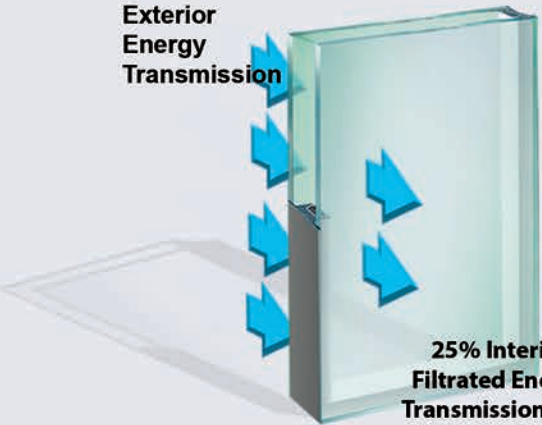

25% Interior
Filtrated Energy
Transmission thru
PRL'S I.G. Unit*



*Graph for illustration only. Actual performance depends on the particular make-up of each unit.

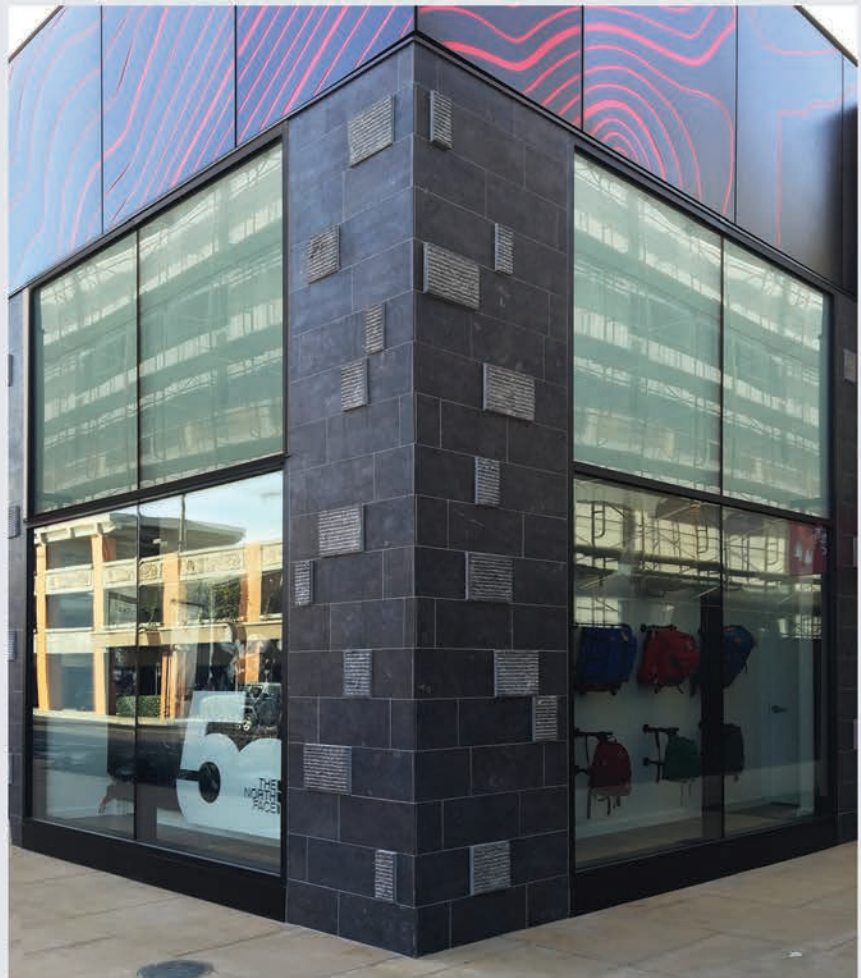

Aluminum Storefront with Insulating Low-E Glass Unit

INSULATING GLASS UNITS- Applications



90 Degree Max Aluminum Slider with Low E Glass IG Units



Aluminum Storefront with IG Units

INSULATING GLASS UNITS- Glass Combinations

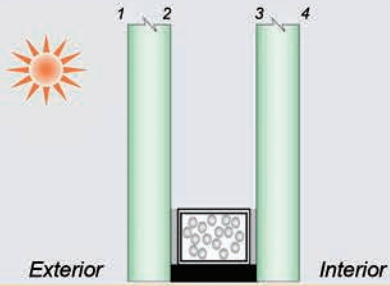

Double-Glazed IG Unit

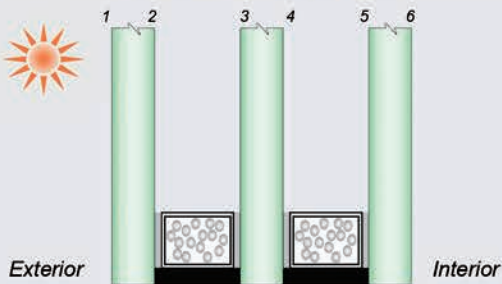

Triple-Glazed IG Unit

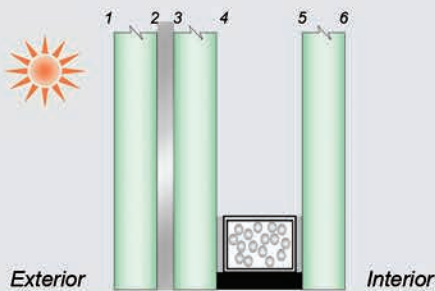

IG Unit Laminated Outboard

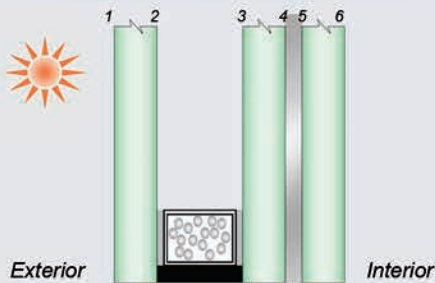

IG Unit Laminated Inboard

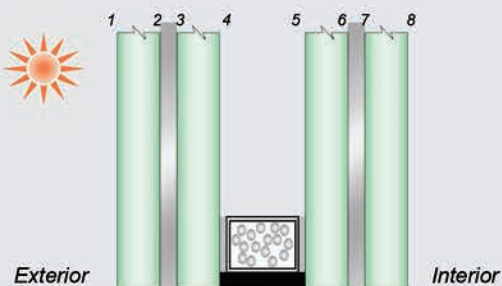

IG Unit Laminated Inboard/Outboard

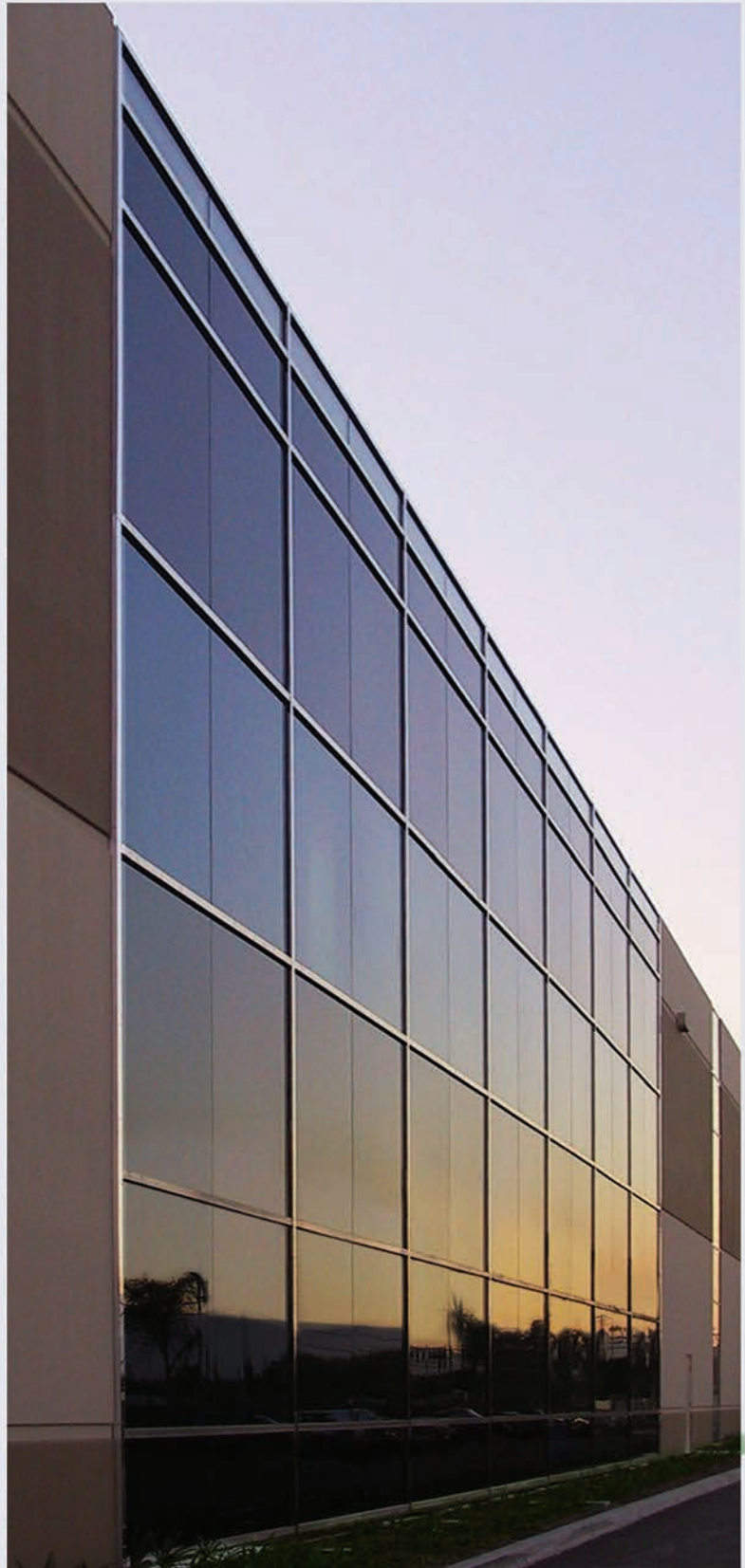

Aluminum Curtainwall with Reflective Glass IG Units

INSULATING GLASS UNITS- Applications



Max' Aluminum Slider with Solarban 60 Low-E Glass IG Units



Aluminum Storefront with Reflective Glass IG Units

LAMINATED GLASS

Offers Unlimited Glass Make-up Possibilities to Perfectly Fit your Project's Needs



Laminated Glass with White SentryGlas®

ENDLESS LAMINATED GLASS POSSIBILITIES



PRL GLASS SYSTEMS

(800) 433-7044

www.prlglass.com

LAMINATED GLASS- Features

- Defined as “Two or more lites of glass permanently bonded together with an interlayer material”.
- Our process bonds the glass and interlayer together under pressure and heat.
- Can be made using:
 - Annealed, heat strengthened or tempered glass
 - Tinted, reflective, textured, mirror and some low E
- Available sound control with custom make-ups
- UV-blocking properties
- Considered safety glass
 - If glass breaks, glass fragments adhere to interlayer Reducing the risk of injury
- Meets:
 - ANSI safety standards
 - ASTM standards for Laminated Architectural Flat Glass
- Max thickness is 3” overall
- Max size : 96” x 155”
- Available custom made laminated glass
- We offer the fastest lead times in the industry



PRL is proud to be able to offer you custom made laminated glass with the fastest lead times in the industry.



Stand-off Handrail System with Laminated SentryGlas®

LAMINATED GLASS



Stand-off Handrail System with Laminated SentryGlas®



Max Sliders with Sound Control Laminated Glass

PRL GLASS SYSTEMS

(800) 433-7044

www.prlglass.com

LAMINATED GLASS

Sound Control

PRL Sound-Control Laminated Glass is detail manufactured with a special acoustic grade PVB interlayer.

This unique interlayer has advanced the technology for high-grade acoustic control. When used with IG multiple combinations, extraordinary sound reduction can be obtained.



Max' Aluminum Sliders Shown with Laminated Sound Control IG Units



Project with Max' Aluminum Slider Systems & Sound Control Glass

PRL GLASS SYSTEMS

(800) 433-7044

www.prlglass.com

LAMINATED GLASS

 **Sound Control**



251 Storefront Series with Super Neutral SN 68HT Sound Control Laminated Glass

LAMINATED GLASS



Decorative

A broad variety of options

PRL's custom Decorative Laminated Glass has contributed to complete tasteful and refined décor with unlimited adaptability to unique design concepts.

Unlimited options for the laminated interlayer

- Elaborate shapes
- Pattern cutting
- Third party hardware or elements
- Special glass
- Fabrics



Full Frame Cladded Door with Custom Laminated Glass



Aluminum Door with Custom Wire Mesh Laminated Glass

LAMINATED GLASS



Decorative
A broad variety of options

Custom Interlayer with Fused Wood Veneer & Samson Hinge



Laminated Glass with Lace Interlayer



Entrance Doors System with Custom Laminated Glass

PRL GLASS SYSTEMS

(800) 433-7044

www.prlglass.com

LAMINATED GLASS



-  1 CORAL ROSE
-  2 AQUAMARINE
-  3 SMOKE GRAY
-  4 SAHARA SUN
-  5 RUBY RED
-  6 SAPHIRE BLUE
-  7 EVENING SHADOW
-  8 GOLDEN LIGHT
-  9 DEEP RED
-  10 TRUE BLUE
-  11 TANGERINE
-  12 OCEAN GREY

PRL Rainbow laminated colors can provide the color tint you are looking for. Our color interlayers are available in 12 standard shades that can be used for interior and exterior applications. These shades were created to match industry glass tints. The standard colors can also be combined to produce over 1,000 transparent or opaque colors. Now architects and designers can design their own color with so many options. The Rainbow laminated color glass interlayers are fade resistant.



Custom Translucent Wall/Divider in Rainbow Sapphire Blue



Interior Storefront with Custom Rainbow Colors Laminated Glass



(800) 433-7044

www.prlglass.com

LAMINATED GLASS



Custom Colors Laminated Glass



Entrance System & Storefront with Aquamarine Laminated Glass

LAMINATED GLASS

SentryGlas®

PRL offers fabricated laminated glass with SentryGlas® ionoplast interlayer. This is a very durable interlayer with superior resistance to weathering, moisture intrusion and sealant contact problems. It is significantly stronger and more rigid than standard PVB interlayers, making it ideal for impact rated and structural applications. PRL Glass recommends all glass entrance doors be fabricated with SentryGlas® interlayer.



*Sample shown with
White SentryGlas®*



All Glass Entrance Doors with Laminated SentryGlas® and Panic Device



Structural Safety Laminated SentryGlas® with Custom Fitting

LAMINATED GLASS



Ultra Narrow Max® Aluminum Slider with SentryGlas® Laminated Glass



Accordion Bifold Aluminum Slider with Hurricane Resistant Laminated Glass

LAMINATED GLASS

Bullet Resistant



PRL's bullet-resistant glass is thinner and lighter than all other similar products on the market. We use Makrolon polycarbonate to provide no-spall ballistic protection, while the Marnot anti-weather polycarbonate provides scratch resistance. Our bullet resistant product has been tested and conforms to the requirements of UL752.S. It has been design to meet Level 3 ballistic resistance, and is only 1 1/16 inch thick.

- Maximun size- 48" x 96"
- Thickness & Lighter Alternative
- Full Range / No Spall Protection
- Polycarbonate Scratch Resistance Glass
- High Ballistic Resistance without Excessive Weight



Level 3 Bullet Resistance Glass



Medium Stile Full Frame Doors with Bullet Resistant Glass



Full Frame Entrance Doors with Bullet Resistant Glass

LAMINATED GLASS

Bullet Resistant



Stainless Steel Full Frame Doors with Bullet Resistant Glass



Monumental Entrance Doors with Trims in Muntz Cladded Finish and Bullet Resistant Glass

PRL GLASS SYSTEMS

(800) 433-7044

www.prlglass.com

LAMINATED GLASS





Our Max Slider Systems include PRL's Aluminum Extrusions, glass and weather-stripping technology. This technology provides weather tight features that narrows the gap of acceptable water and air infiltration compared to the industry standards/requirements.



Max Aluminum Slider with Hurricane Resistant Glass

ZONE 3 suitable

-  Wind Zone III (200mph)
-  Hurricane-Susceptible Region



Our sliders passed the Hurricane Impact tests in laboratory controlled conditions
*test reports available upon request

LAMINATED GLASS

PRL laminated glass is ready to assist with Tempered, Safety, Sentry, Bullet Resistant, Missile & Hurricane Resistant glass requirements. PRL offers a lighter, stronger safety glass that can stand up to greater threat levels.

Bullet Resistant
Laminated Glass

Bullet Resistant up to Level 3

- High Ballistic Resistance without excessive Weight or Thickness
- Thinner Make-Up Fit Security Doors Glazing Pocket

Bullet Resistant

Falls out in one piece when broken

Standard levels of safety with small particles from broken tempered glass

- Improved Safety when broken

Tempered/PVB Laminated Glass

Safetyglas® Tempered laminated glass remains standing when broken

- Tolerates high stress loads (bolted & frameless).
- Reduces deflection & withstands greater wind forces.

Tempered/SentryGlas®

Hurricane Impact Rated

- Hurricane resistant.
- Higher performing structural interlayer.

Missile Impact

SPANDREL COLOR GLASS

For Exterior and Interior Applications



















PRL Spandrel Glass with its nearly unlimited range of colors offers greatly increased options for interior and exterior glass applications. Color matching is no problem for PRL, using a computerized color spectrophotometer. When spandrel is used on clear or reflective glass it adds shimmering, jewel like color to the interiors of hotels, shops, and restaurants.

Offered with ICD OPACI-COAT 300 water based silicone coat. Heat-treating is not required.

Applicable on annealed or tempered, Low Iron, clear, and reflective glass products. Available in standard and custom colors. Unlimited additional custom colors can be provided at additional cost. Please consult our sales office for more information.

STANDARD COLORS

	#1-818 Black
	#3-820 Harmony Gray
	#4-822 Harmony Bronze
	#6-0025 Harmony Blue
	#2-743 Harmony Solex
	#4-975 Lava Bronze
	#2-0225 Evergreen
	#0-0186 Light White
	#0-0020 Snow White
	#0-1060 Primary White
	#1-0016 Charcoal
	#3-0586 Medium Gray
	#3-0770 Warm Gray
	#3-747 Harmony Graylite#14
	#3-967 Black-Gray
	#4-0925 Neutral

Custom Colors

	#2-0213 Aged Copper
	#6-0194 Fjord
	#5-936 Red

Note: Samples shown are for illustration purposes only colors may vary from actual samples. Please consult PRL for details and availability.



Custom Spandrel Counter Top



Black Spandrel Wall Panels

SPANDREL COLOR GLASS- Features

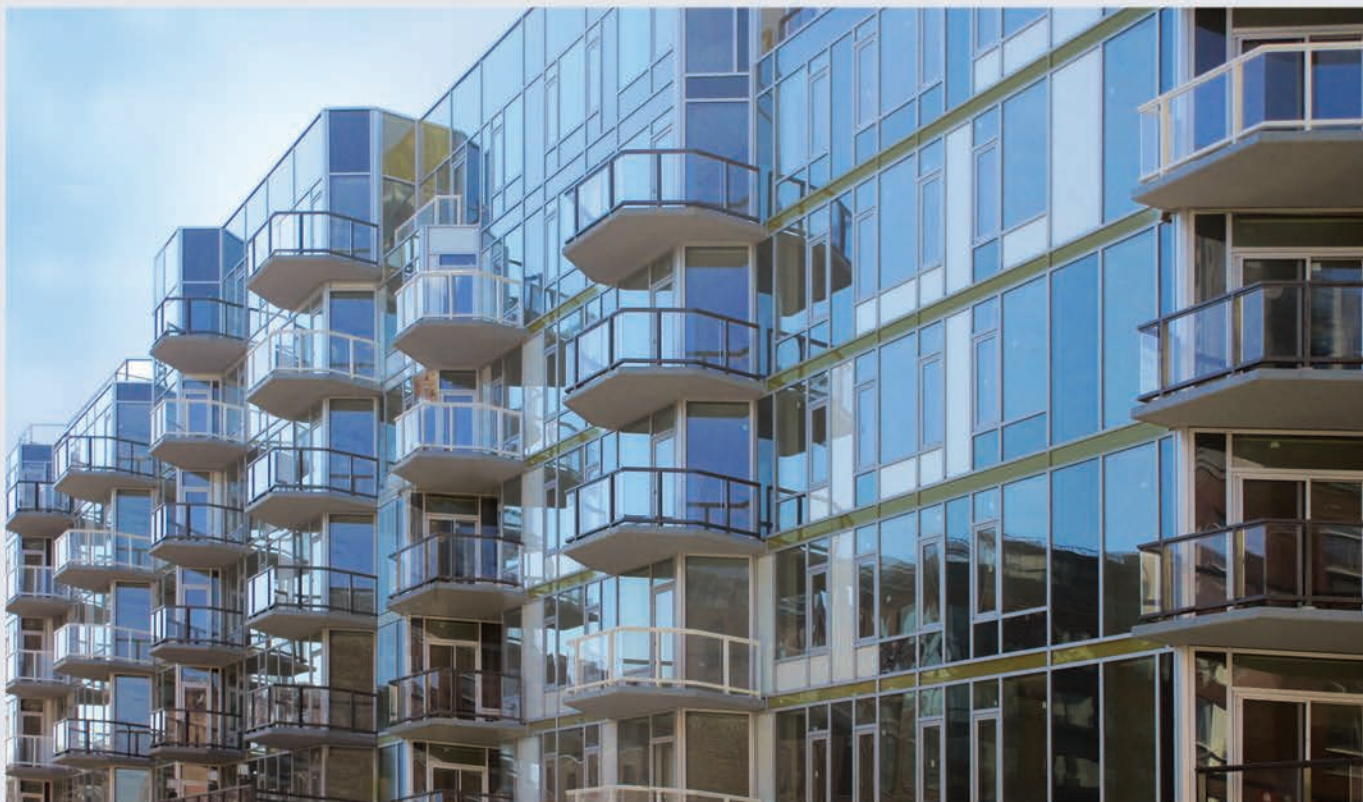

Curtainwall with Color Spandrel IG Units



Storefront with Spandrel Infill Panels

SPANDREL COLOR GLASS- Interior Applications



Custom Color Back Wall & Cabinets Fascia



Decorative Back Splash Wall with Custom Color

SPANDREL COLOR GLASS- *Interior Applications*



Spandrel Panels Custom Color Wall Interior Glass Application



Foyer Backwall shown with Custom Color Spandrel

SPANDREL COLOR GLASS- IG Units Exterior Applications



Curtainwall Infill Panels with Custom Color Spandrel Glass

PRL GLASS SYSTEMS

(800) 433-7044

www.prlglass.com

SPANDREL COLOR GLASS- IG Units Exterior Applications



IG Units with Custom Color Spandrel Glass

PRL GLASS SYSTEMS

(800) 433-7044

www.prlglass.com

MIRRORS

Enhance your Space with Elegance



Wall Mirror with Light Fixture Custom Cut Outs



Low Iron Mirror with Sandblasted Border

MIRRORS- Selection

PRL enhances the mirror elegance with

- Polished Edges
- Beveled Edges
- Multiple bevels
- Sandblast artwork



Clear Mirror with Light Fixture Cut Outs

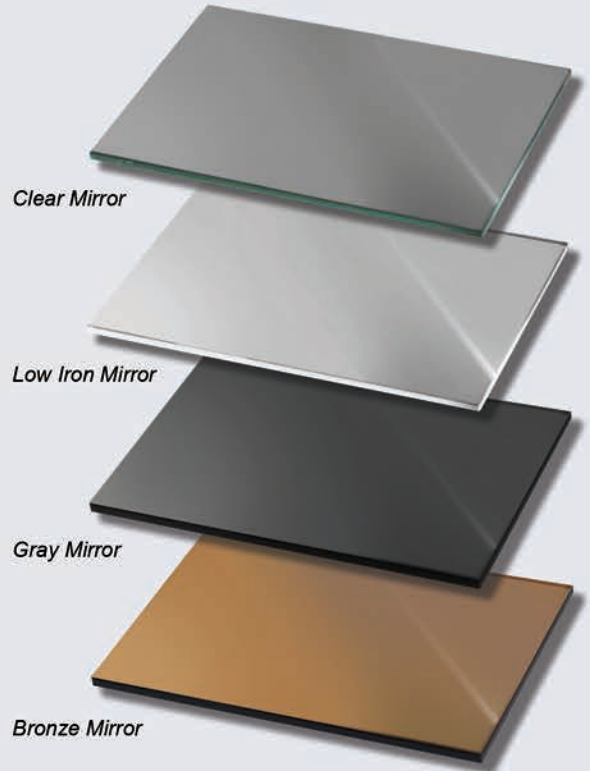

Clear Mirror

Low Iron Mirror

Gray Mirror

Bronze Mirror



Custom Clear Mirror with Custom Stand-off Mount

Features:

- Brighter
- Excellent clarity

Unlimited Applications:

- Gym
- Beauty Salon
- Designer Couture
- Hospitality
- Event Halls
- Boutiques
- Spas

MIRRORS- Low Iron

PRL Low-Iron mirror perfectly suited when you wish to achieve the truest and clearest reflection possible.

PRL specializes in fabricating custom mirrors to your specifications. Our goal is to deliver a superior quality mirror product.



Low Iron Mirror with Etching for Lighting



Clear Mirror vs Low-Iron Mirror



Custom Low Iron Wall Mirror with Round Lighting Cutouts

MIRRORS- Applications



Custom Fabricated Mirrors with Etching for Back Lighting



Custom Clear Mirror Configurations



Mirror with a Center Circular Cut Out

PRL GLASS SYSTEMS

(800) 433-7044

www.prlglass.com

SANDBLAST

Enhance Glass Elegance with Surface or Deep Carved Custom Designs

PRL Sandblast artwork enhances glass elegance with surface or deep carved custom designs such as, logos applications, floral designs, mythical concepts, abstract, contemporary designs, or ornamental design. Applicable in most of our product line such as, entrance doors, sliding door systems, tabletops, decorative glass, shower enclosures, glass specialties, handrails, and many others.

- Carved
- Surface Sandblast
- Artistic
- Custom edges
- Custom
- Tri-Dimensional Sandblast

PRL Recommends
Diamond Seal
on your sandblast Glass



Entrance System Ornamental Design



Glass Partition with Custom Sandblast Design



Shower Unit with Gluechip Border



Clear Glass with Custom Sandblast

PRL GLASS SYSTEMS

(800) 433-7044

www.prlglass.com

SANDBLAST GLASS- Multiple Applications



Double Doors with Custom Sandblast Artwork



Displays with Logo Application



Entrance System Contemporary Artwork



Partition Oceanic Design



Detail sandblasting checked pattern on a Tiffany Slider with lock Housing/CB Pull.

SANDBLAST GLASS- Brand Identity Artwork



Infill Panels Glass Wall with Gradient Sandblast Design



Office Doors with Custom Sandblast Logo Design



Glass Partition with Custom Sandblast

SANDBLAST GLASS- *Border Designs*



Handrail System with Custom Sandblast Border



Bifold Aluminum Slider with Reflective Glass & Custom Sandblast Border

PRL GLASS SYSTEMS

(800) 433-7044

www.prlglass.com

SANDBLAST GLASS- Artistic Designs



Three Dimensional Sculptured Sandblast Mythical Art Design

3 Glass Pieces Custom Installed with Color Lights for Special Effects



Custom Cut Glass Before Installation

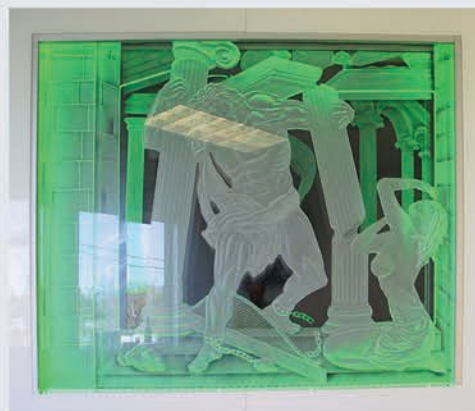

PRL GLASS SYSTEMS

(800) 433-7044

www.prlglass.com

SANDBLAST GLASS- Artistic Designs



Oversize Glass Panel with a Large Door Cut-out



Splash Panel with Custom Sandblast Mermaid Design



Custom Oceanic Sandblast Design Partition



Full Frame Door with Custom Design

CUSTOM TABLETOPS

Artistic, Beautiful, and Creative Applications for Residential and Commercial

PRL custom tabletops have contributed to complete tasteful and refined decor. Custom shapes and edging on heavy glass reflects PRL expert craftsmanship. Offering, standard geometry, complex shapes, overlay and custom inset (frame or pattern are required).

Among other applications are:

- Residential
 - Dining
 - Coffee
- Office
 - Conference
 - Desk
- Commercial
 - Display
 - Countertop



Round Tabletop with Flat Polished & Custom Center Cutout



Tinted 3/4" Glass Round Tabletop



Round Tabletop Custom Mount

TABLETOPS- Custom Applications



Clipped Corners Rectangular Tabletop with Custom Sandblast



Oversized Conference Tabletop with Custom Edge

TABLETOPS- Fabrication

PRL's glass tabletops are suitable for indoor and outdoor furniture. When designing your custom glass tabletop, PRL offers a wide selection of options for shapes, corners, glass types, edge work, and custom treatments.

Design the unique table for your special project. PRL will also cut to fit to your pattern or table base.

**Consult us for details*



CORNERS:

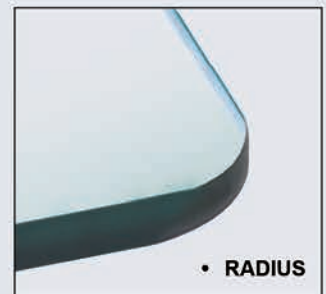
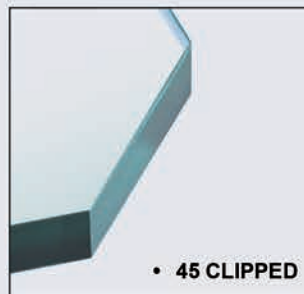
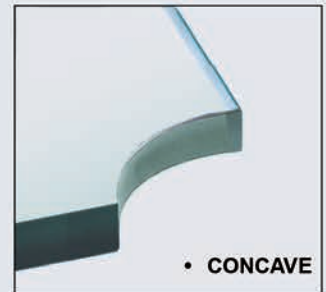
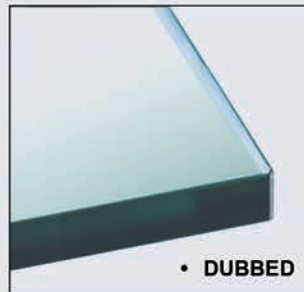
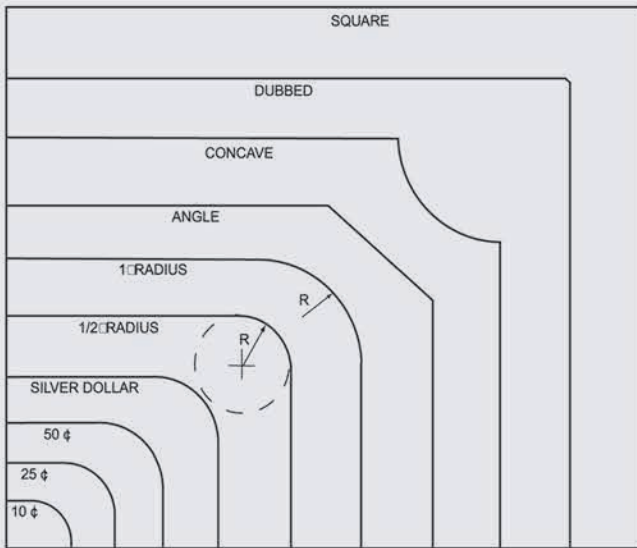

THICKNESS:

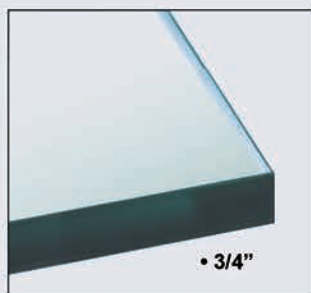
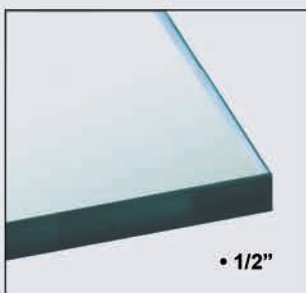
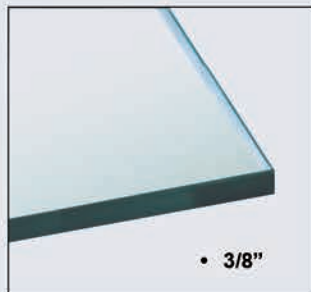
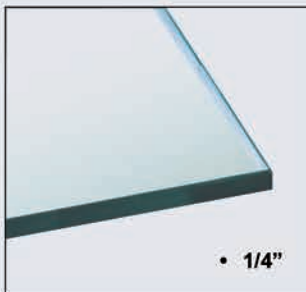

TEXTURE:

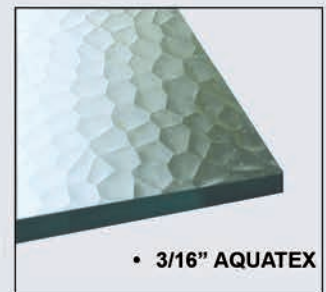
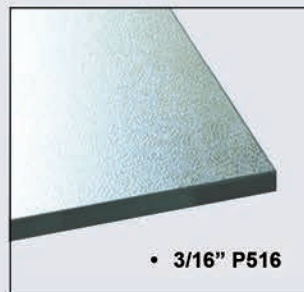

TABLETOPS - Glass Edges

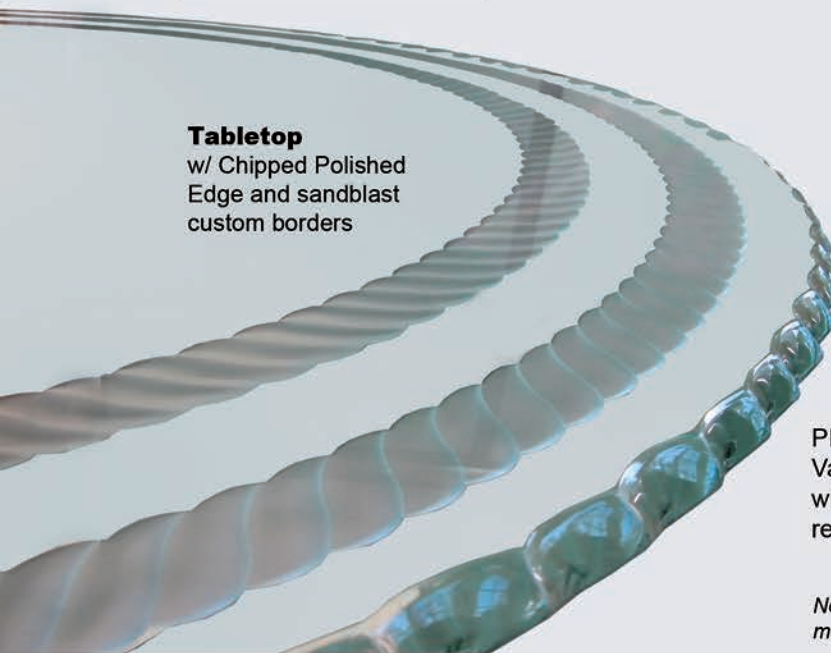
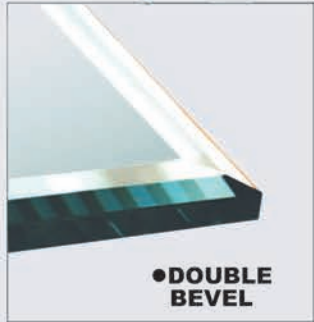
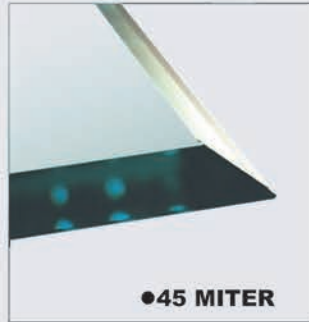
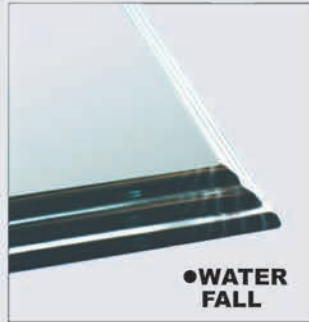
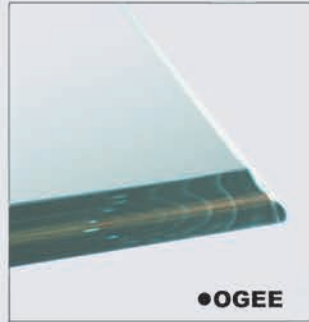

PRL natural glass elegance with innovative hand crafted edges. Various edges are offered from ground to polished bevel for a wide range of applications. Customized edges are available upon request. Please consult PRL for details.

Note: Samples shown are for illustration purposes only, color/designs may vary from actual samples. Please consult prl glass for details

TABLETOPS- Glass Fabrication

CUSTOM DESIGN*

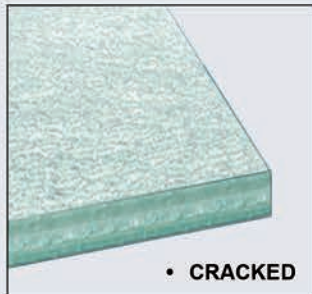
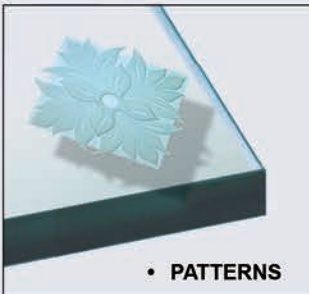
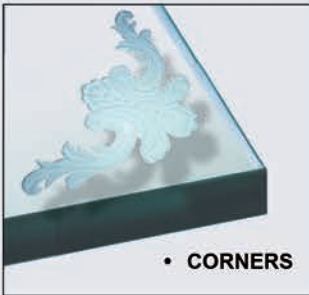

**specifications required*



Tabletop with Custom Sandblast Design

COLORS:

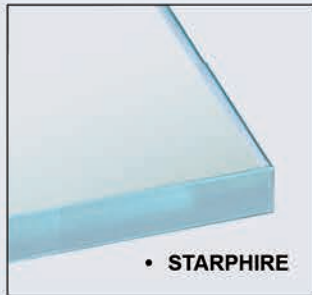
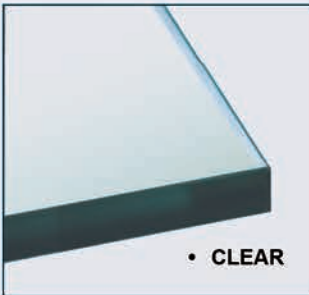

Tabletop in Bronze Color Glass

TABLETOPS- Oversize Conference Tables



Rectangular Tabletop with Custom Sandblast



Oversize Tabletop with Water Fall Glass Edge and Custom Sandblast & Gluechip

GLASS SPECIALTIES

Custom Work with Maximum Craftsmanship Creating Elegance & Style



Conference Room with Custom Sandblast/Gluechip Tabletop & White Spandrel White Board

GLASS SPECIALTIES - Features

PRL glass custom applications offer an unlimited adaptability to unique design concepts integrating the beauty and strength of glass with the elegance of other hardware to create distinguished exhibition elements. Glass applications allow natural lighting to fill interior spaces while still allowing practical function and the view of fine décor.

Custom glass applications are unlimited for corporate, commercial, office and residential applications. PRL offers unlimited glass options such as:

- Clear
- Tinted Uncoated
- Sandblast
- Spandrel
- Low Iron
- Low E
- Reflective
- Textured
- Laminated
- Custom



All Glass Interior Wall Dividers with Custom Sandblast



Spandrel Glass Panel Column Cover

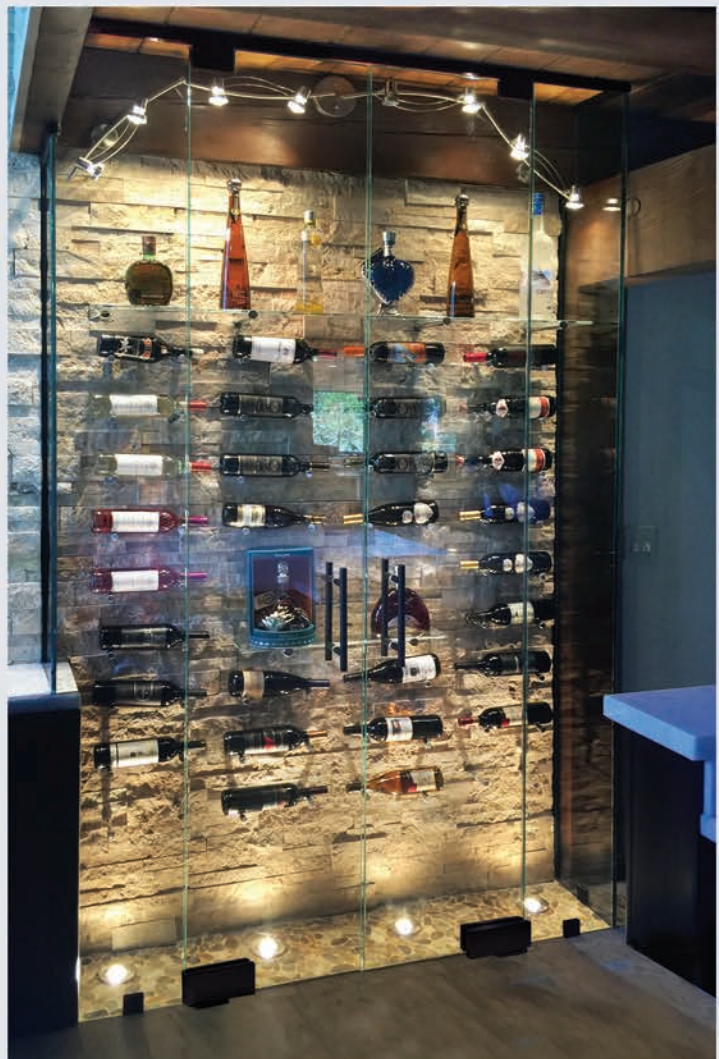

Custom Wine Cellar A Style Doors & Samson Closer

GLASS SPECIALTIES- Commercial Applications



Custom Sculpture made with 180 Layers of Glass



Custom All Glass Wine Cellar

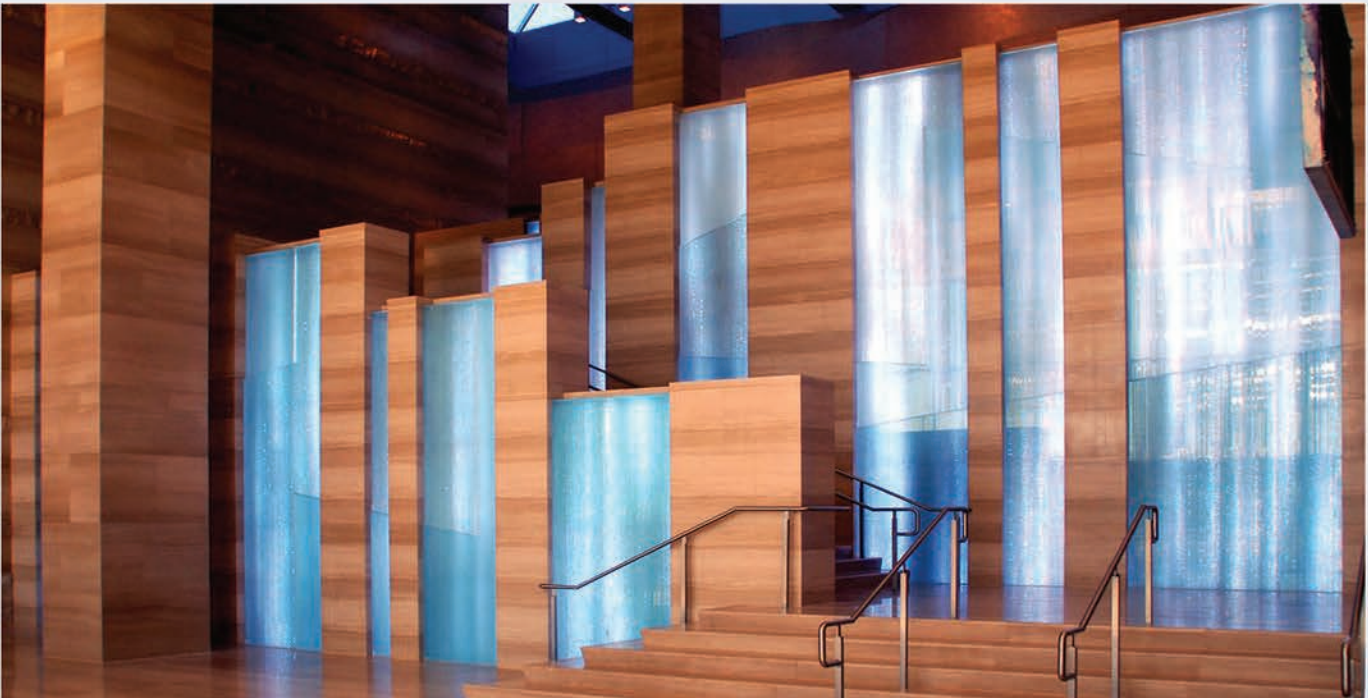

Custom Textured Laminated Glass Walls

GLASS SPECIALTIES- Commercial Applications



All Glass Tiffany Slider with Acid Etch Glass



Aluminum Gate with Acid Etch Glass



Custom All Glass Wine Cellar

ALL GLASS ENTRANCE SYSTEM

The Highest Quality Complete Entry Systems with the Fastest Lead Times in the Industry



Custom Height P-Style Door with Full Height Deadbolts

PRL GLASS
SYSTEMS

(800) 433-7044

www.prlglass.com

ALL GLASS ENTRANCE DOOR SYSTEMS- *Configurations*

PRL all glass doors are available in various standard styles and are offered with continuous rails or corner patch combinations. Available metal finishes are stainless steel, brass (satin or polished), anodized aluminum and powder coat or Kynar painted.



BP-Style Door / Entrance System with 2" Door Rail



A-Style Door System with Samson Patch & Full Height Ladder Pulls

Standard Configurations



P-STYLE

Continuous horizontal top and bottom rails from any PL-Series rails.



BP- STYLE

Corner patch rail in a 9 1/2" from any PL-Series rails or any PL-Euro series fittings, and a continuous horizontal bottom rail from any of our PL- series rails.



F-STYLE

Corner patch rails at pivot and lock points in a 9 1/2" section from any PL-Series rails or PL-Euro series fittings.



A-STYLE

Corner patch rails at pivot points (no lock patch) in a 9 1/2" section from any PL-Series rails or PL-Euro series fittings.

Custom Door Designs are also available for a wider variety of applications.

ALL GLASS ENTRANCE DOOR SYSTEMS- *Applications*



P-Style Entrance Systems with PL-100 Panic Device and FS Exterior Pulls



Office A-Style Interior Doors with PL-Short Ladder Pulls

PRL GLASS SYSTEMS

(800) 433-7044

www.prlglass.com

ALL GLASS ENTRANCE DOOR SYSTEMS- *Custom Configurations*



BP Style Door with Custom Stabilizer Glass Fins



Custom Height All Glass Entrance Doors in Polished Brass Finish



PRL's Interior & Exterior Oversize All-Glass Entrance Doors with heavy duty hardware to accommodate special width or Height. A variety of options of custom pulls and hardware. With PRL the possibilities are endless!



Oversize Width All Glass Entrance Door with Specialty Hardware

ALL GLASS ENTRANCE DOOR SYSTEMS- Door Hardware

EURO FITTINGS



PL-450
TRANSOM/SL/FIN/PIVOT BRACKET
4 1/8"H / 8 1/2" W



PL-440
TRANSOM/ SL / PIVOT BRACKET
4 1/8" H / 8 1/2" W



PL-414/424
BOTTOM OR TOP PATCH FITTING
2"H / 6 1/2" W



PL-16500
LOCK PATCH FITTING
2"H / 6 1/2" W

SIDELITES HEADER

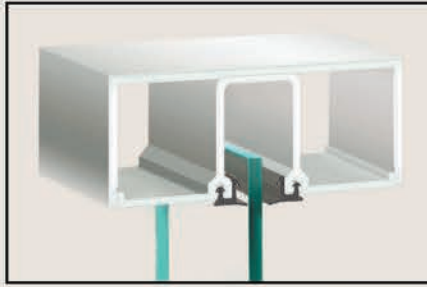

PL-400SH
1 3/4" H X 4" W



PL-450SH
1 3/4" H X 4 1/2" W

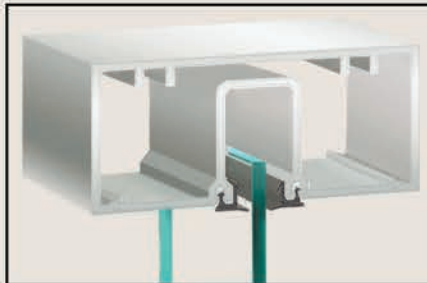

PL-250SH
2" H X 4 1/2" W

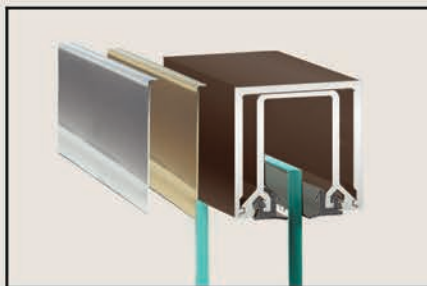

PL-175SH
1 3/4" H X 1 3/4" W

DRYSET DOOR/SIDELITE RAILS



PL-1000DS
2 1/16" W x 10 1/8" H



PL-600DS
2 1/16" W x 6" H

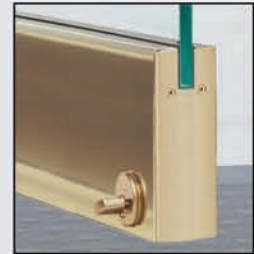

PL-350DS
2 1/16" W x 4 1/4" H



PL-150DS
2 1/16" W x 4 1/4" H



PL-250DS
2 1/16" W x 2 1/4" H

**Sidelites applications omits the lock*

ALL GLASS ENTRANCE DOOR SYSTEMS- *Door Hardware*

LOCKS



PL-CLH2
DEADLATCH LOCK
10" H / 6" W



PL-16300
LOCK PATCH FITTING
4 1/4" H / 3" W



910.003
STUDIO CLASSIC
3/8" & 1/2" glass



910.200 / 910.220
STUDIO RONDO LOCK/KEEPER
3/8" & 1/2" glass

PULLS



PL-3
10"/12"/18" CC



PL-3 Offset
10"/12"/18" CC



PL-5
12" CC



PL-8
10"/28" CC

LADDER PULLS



PL-LADDER
12"/24", 24"/36" 36"/48",
60"/72", 72"/84" CC/OAL



PL-LPSQ
24", 36", 48", 60",
72", 84" STD OAL

PL-SFU
44"/48"- 68"/72"
80"/84" CC/OAL

ALL GLASS ENTRANCE DOOR SYSTEMS- *Door Hardware*

OVERHEAD CLOSER

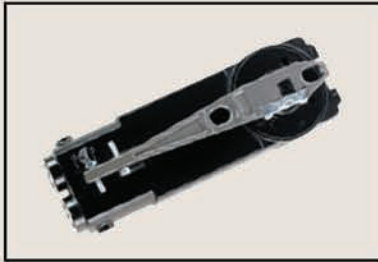

OHCADJ
Adjustable Overhead Closer
90/105 Degrees HO/NHO

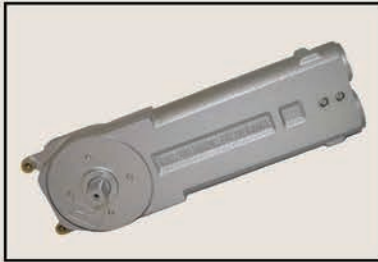

RTS88
RTS 88
Body only

BOTTOM CLOSER



BTS80
75/90°, 75/105°, 80



RIXSON
85°-105° Hold/No Hold

ELECTRIC & MAGNETIC STRIKE

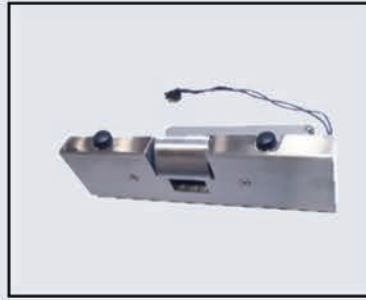

FA3101
310-1 Electric strike/single



FA3101D
310-1 Electric strike/double

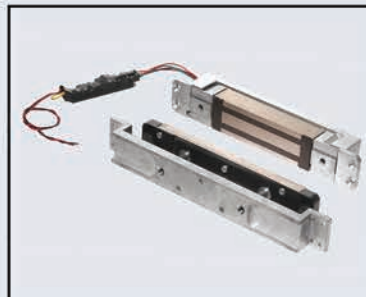

GF3000
Locknetic GF3000 magnetic lock



FS23M
SDC Electric deadbolt lock

PIVOTS

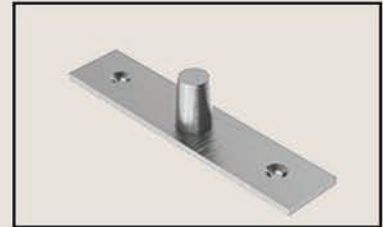

PL10170
Surface Mount Top Pivot



Offset Top Pivot
1 1/2", 3/4"



PL11500
Surface Mount Bottom Pivot



WB8062
Walking Beam Top Pivot



M19
M-10 Intermediate Pivot

ALL GLASS ENTRANCE DOOR SYSTEMS- Door Hardware

DOOR HEADER

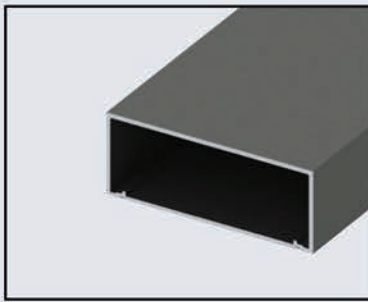

PL400DH
1 3/4" X 4" Door header

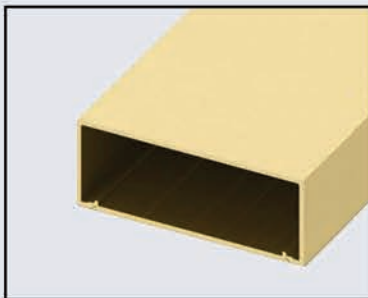

PL450DH
1 3/4" X 4-1/2" Door header



PL250DH
2" X 4-1/2" Door header

***Available Finishes in: #4 Brushed Stainless Steel #8 Polished Stainless Steel, Bronze Anodize, Clear Anodize, Mill Finish, Satin Brass and Polished Brass. Consult us for details.*

FLOATING HEADERS

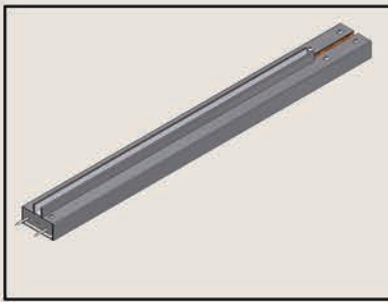

36FH
36" Floating header

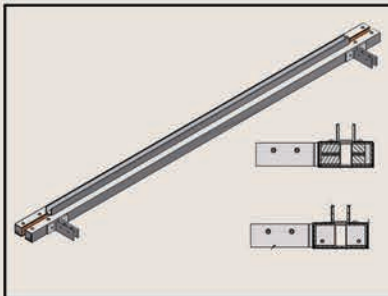

72" Floating header
with and without fins

U-CHANNEL (TOP & BOTTOM)



WET-GLAZED

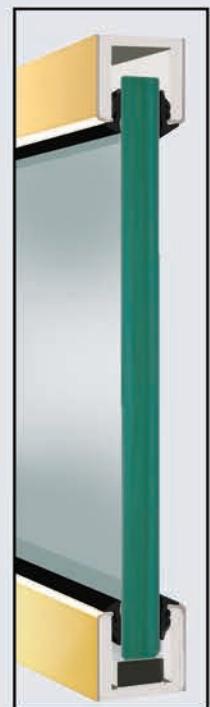

DRY-SET

Aluminum U-channels
1 x 1, 1 x 1 1/2, 1 1/4 x 1, 1 1/4 x 1 3/4,

THRESHOLDS



TH400
1/2" X 4" Threshold

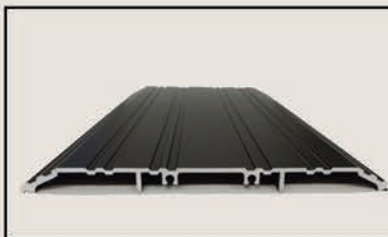

TH037
1/2" X 7" Threshold

PINNING CHANNEL



10INSERT
Pinning Channel
1 3/8" X 2 5/8" X 3/8"

ALL GLASS ENTRANCE DOOR SYSTEMS- *Samson Hydraulic Patch*

PL- SAMSON SERIES

A Strong and unique combination of a Patch & a Closer.

- Maximum Weight 300 lbs
- Maximum Door Width 42 in.
- Maximum glass thickness 3/8"- 9/16"
- Polished or Satin Stainless Steel Cladded Finishes

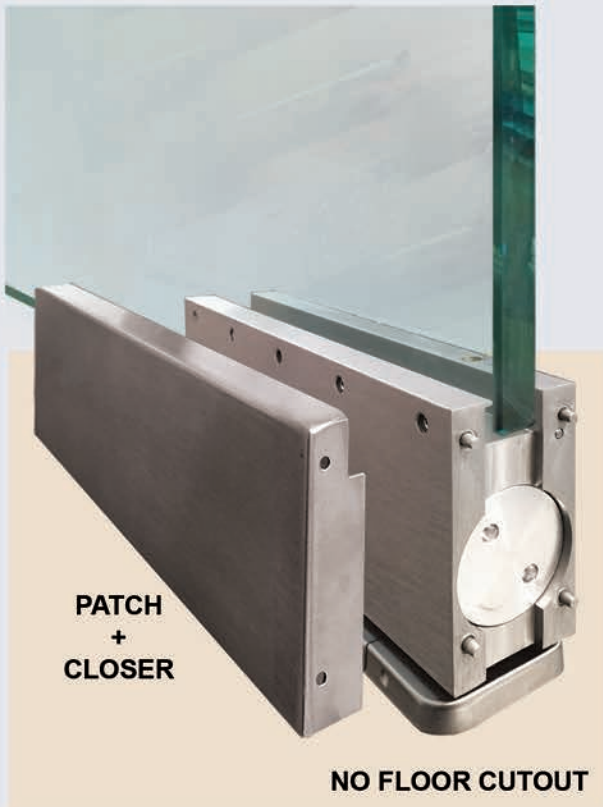

PL-10170
SURFACE MOUNT TOP PIVOT
L 4 3/16" x W 1"



Office Door with Closer/Patch and Top Patch



PL-424
TOP PATCH
L 6 1/2" x H 2"



PL414-HYHD
PL-CLOSER/PATCH
L 9 13/16 x H 3 3/16"

ALL GLASS ENTRANCE DOOR SYSTEMS- *Samson Hydraulic Patch*

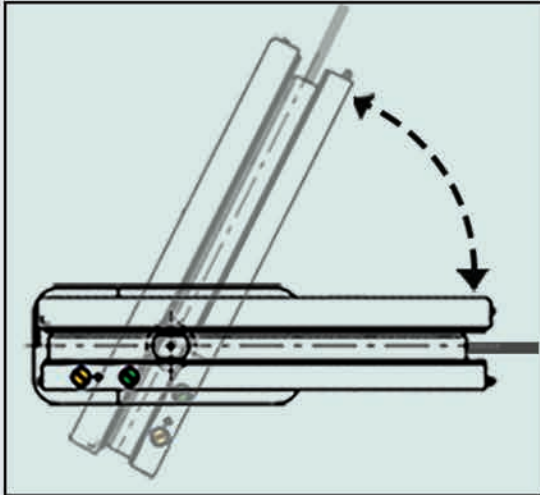

CLOSING SPEED ADJUSTABLE
150° - 10° and 10° - 0°

PL- SAMSON SERIES HYDRAULIC PATCH

The Concealed Floor Spring Closer has a Dual Action Functioning range of 150 degrees making it suitable for single or double action doors and is non-handed making it suitable for both LH and RH doors with a maximum door panel weight of 330 lbs.

It is available with or without the Hold Open feature at 90 degrees.

The Base Plate on the PF Series is also adjustable to ensure alignment of the door panel. The Stationery position of the door can be adjusted horizontally left to right and forward and back by 1/8" with the door opening angle also adjustable by 4°.

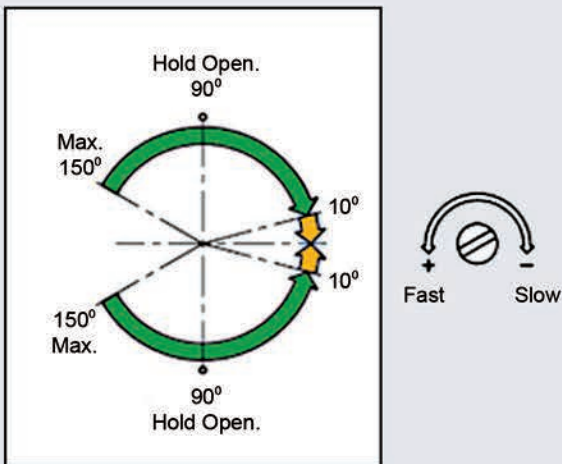

Textured Glass Door/ Wall Partition with Samson Patch & Samson Clamps



A-Stile Doors with Closer/fitting & Top Patch Fitting

PANIC DEVICES

Interior Push Bars for Exterior Doors That Serve the Dual Purpose of Meeting Emergency Egress Code Requirements and Act as Decorative Interior Push Handles



PRL GLASS SYSTEMS

(800) 433-7044

www.prlglass.com

PANIC DEVICE- Features

Features:

- Standard & Custom Configurations/Exterior Handles
- Door stop/Strike bracket (Manual or Electronic)
- Dummy Panic Handles
- Custom Finishes
- All Glass, Full Rail & Custom Mounting
- Secure Cylinder/ Key Housing
- Adaptable to Small Format IC Core Cylinders
- Fastest Leadtimes in the Industry:

UNIQUE



PL101- TUBULAR "MITERED"

CLASSIC



PL100- TRADITIONAL "RADIUSED"

INNOVATIVE



PL102- SQUARED "MITERED"

BIGGER



up to
10 ft
High*

CUSTOM Oversize Width/Height Panic Device

STRONGER than ever.

PRL has successfully completed over **2.0 million uninterrupted cycles of operation** with our PL100 Tubular Panic.



PRL GLASS SYSTEMS

(800) 433-7044

www.prlglass.com

PANIC DEVICE- *Panic Bar Style Options*



Ultra Narrow Cladded Doors with PL 100 Panic Device and FS Exterior Handle



P-Style Entrance Systems with PL-100 Panic Device and FS Exterior Pulls

TUBULAR PANIC OPTIONS

 **1 1/4" Custom Square Bar**

also available

 **1 1/4" Diameter Round Bar**

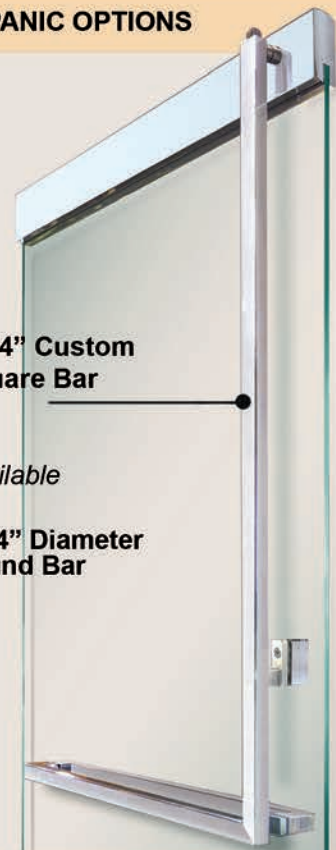

PANIC DEVICE- Full Frame Cladded Doors & All Glass Entrance Doors



Multiple All Glass Entrance System with P-Style Doors & PL 100FS Panic Devices



Multiple Entrance System with Full Frame Cladded Doors & PL 100FS Panic Devices

DEADBOLT LOCKING MECHANISM

Offers Security, Ease of Access and Beauty



Ultra Narrow Cladded Doors with Full Size Top Latch Deadbolt



P-Style Oversize Doors with DB-FS Top Latch Deadbolt



BP Style Door with Floating Header & Top Latch Deadbolt

PRL GLASS SYSTEMS

(800) 433-7044

www.prlglass.com

DEADBOLT- Features

One of PRL's popular locking options is our Tubular Deadbolt Handle. It offers security, ease of access and beauty. This stylish hardware provides a convenient and ergonomically comfortable locking and unlocking height while enhancing your entry with a very elegant, modern, and streamlined appearance. PRL Aluminum custom manufactures our deadbolt handles in-house to your requirements.

Featuring:

- Easily Operable key cylinder out and thumb-turn inside
- 1-1/4 Round or Square Tube profiles available
- Latch option at head or floor
- Custom configurations with full length or half size on request
- **Locking mechanism at a convenient height**



P-Style Doors with Half Size Top Latch Deadbolt

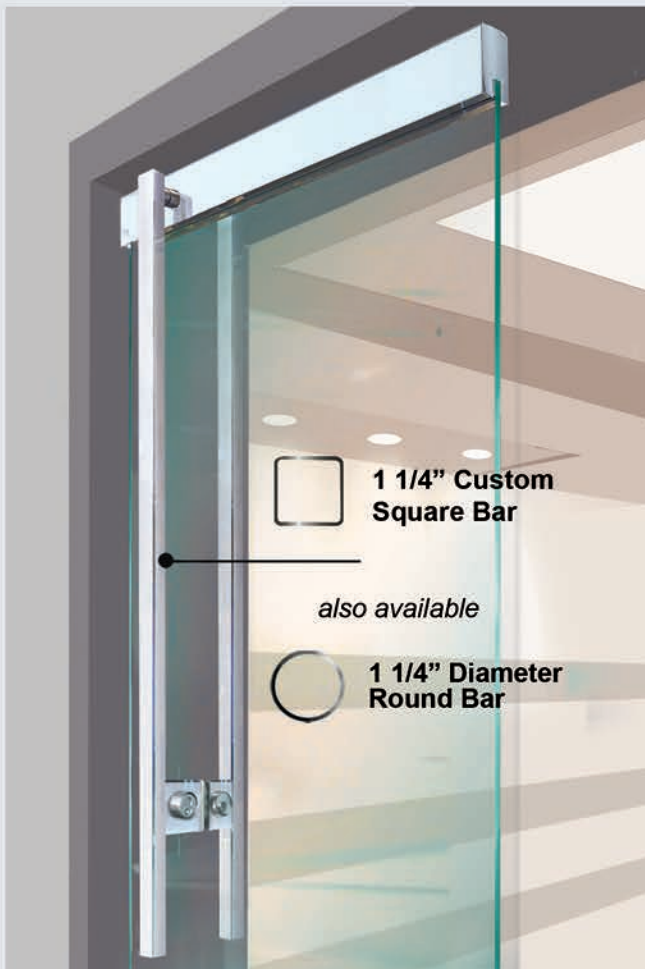

Full Frame Cladded Entrance Doors with Full Height Deadbolt

EASY LOCKING LADDER PULLS

Popular Due to Its Easy Locking Mechanism at Waist Height



Entrance System with Full Height Easy Lock Ladder Pulls



P-Style Doors with Full Height Easy Lock Ladder Pulls

EASY LOCK LADDER PULLS- Features

PRL continues to design, manufacture and develop innovative hardware to complement our variety of door styles. Easy Lock Ladder Pulls are designed to add contemporary functionality to standard & monumental entrance doors.

Featuring:

- Half length locks at head or floor
- Full length locks at head or floor
- Flexible key outside and thumb-turn inside option
- Elegant custom designs
- Custom length available
*consult us for details



- **Easy locking mechanism at a convenient height**



Glass Slider with Custom Easy Lock Ladder Pull



Wine Cellar with Diamond Style Easy Lock Ladder Pulls



Tiffany Slider with Short Easy Lock Ladder Pull

FULL FRAME CLADDED DOORS

Elegant Stainless Steel or Brass a Luxurious Alternate, Cladded Entrance Door Systems



Heavy Gauge Aluminum Cladded Painted Door Systems

PRL is proud to offer our Full-frame Cladded Doors. Providing innovation, elegance, strength and style, our full-framed doors will create an entrance to impress! Available in a variety of architectural finishes and with a premium selection of hardware such as our own tubular panic hardware, PRL provides countless options to create an entrance you'll be proud to display!

Designed with durability, security and style in mind, PRL's full-framed doors are fabricated without glass stops, providing clean, unobstructed sightlines. Extruded in-house, our clad doors are designed with a heavier wall extrusion than standard storefront doors. Center Hung and Offset options are available. We offer three different vertical stiles. Standard top and bottom rail heights are 4", 5" or 10". But PRL is never limited to standard options and can fabricate to any custom sizes specified! Our doors accommodate glass thicknesses from 1/4" to 1". Numerous laminated glass options are available in-house, including PRL's exclusive 1-1/16" BR. For improved weather control our doors are equipped with state-of-the-art adjustable weather stripping. Our experienced sales team is available to assist with any design questions and quotations. Please feel free to contact our Door Department.

PRL GLASS
SYSTEMS

(800) 433-7044

www.prlglass.com

FULL FRAME CLADDED DOORS- Features



Full Frame Colossal Atrium Entrance System

Complete Entrance Systems

- Without Glass Stops
- Unlimited Glass Options
- Luxurious Cladded Finishes
- Specialty Hardware & Panic Devices

FINISHES:



Polished Brass



Polished Stainless Steel



Satin Brass



Brushed Stainless Steel

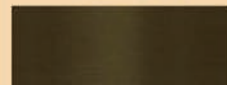

US10B Oil Rubbed Bronze

GLASS THICKNESS:



1/4"



3/8"



1/2"



1"(IG Unit)

VERTICAL DOOR STILE:

Wide Stile:

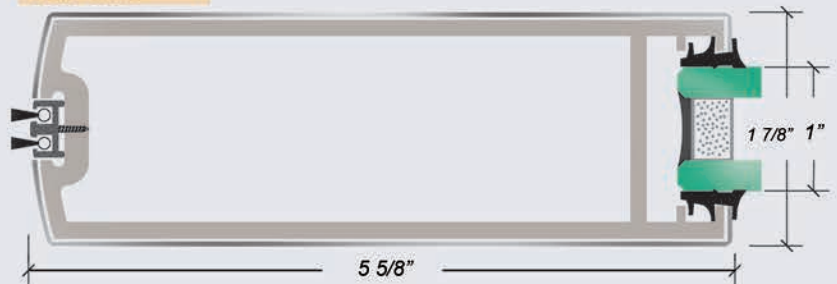

Medium Stile:



Narrow Stile:

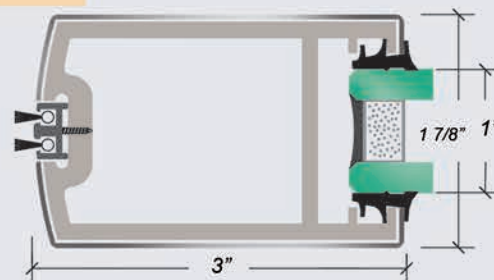

FULL FRAME CLADDED DOORS- *Applications*



Medium Stile Door with PL-100 Panic Device

PRL complete entrance systems are manufactured and assembled in house. All you have to do, is give us your opening dimensions and we will provide you with a complete door package ready to install.

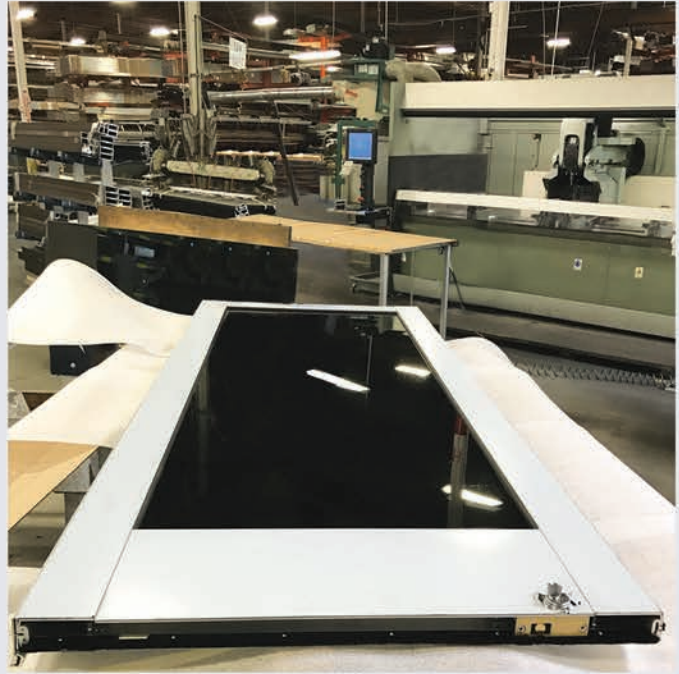

Stainless Steel Clad Full Frame with IG Unit & Continuous Hinge



Full Frame Doors in Satin Stainless Steel Finish with Offset Pivots, VD Panic Hardware and Offset Ladder Pulls

PRL GLASS SYSTEMS

(800) 433-7044

www.prglass.com

FULL FRAME CLADDED DOORS- Applications



Narrow Stile Heavy Aluminum Cladged Painted Door Systems



Double Doors Full Frame Doors in Satin Brass Finish

ULTRA NARROW CLADDDED DOORS

Spontaneous Entrance Doors Giving the Impression of All Glass Doors with Very Narrow Vertical Stiles



Monumental I-Line Stile Entrance Doors with PL100F Panic Device

WS-450

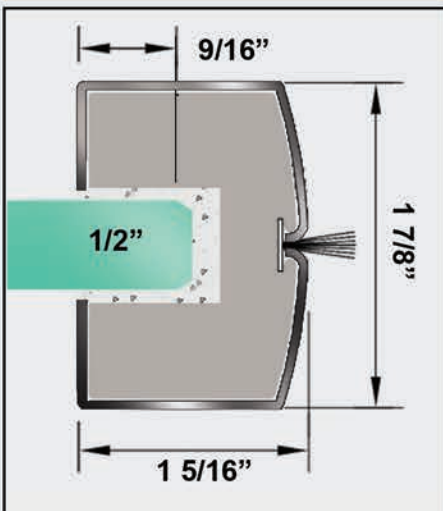

WS-475

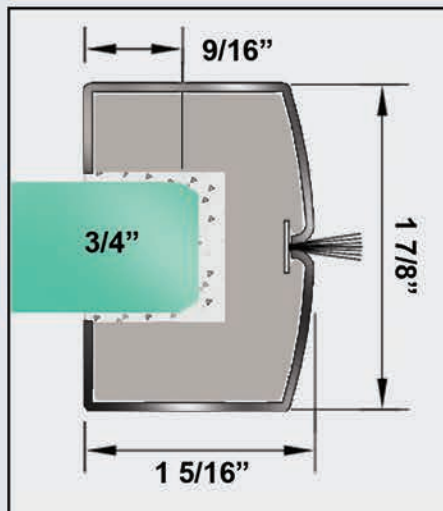

WS-878

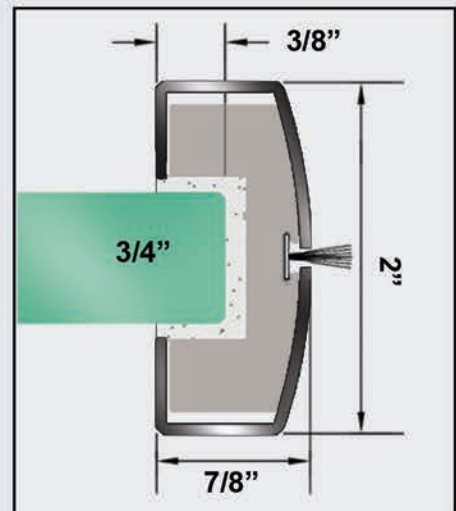

AVAILABLE FINISHES:



Polished Brass



Polished Stainless Steel



Clear Anodized

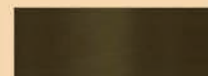

US10B Oil Rubbed



Satin Brass



Brushed Stainless Steel

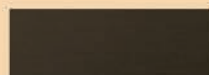

Bronze Anodized



Custom Painted Colors Available*

*Clear Anodized subtract 1/8" of the overall width

PRL GLASS SYSTEMS

(800) 433-7044

www.prlglass.com

ULTRA NARROW CLADDED DOORS- Applications



Custom Height Ultra Narrow Cladded Doors with Custom Height Ladder Pulls



Ultra Narrow Cladded Doors in Polished Brass Finish



Ultra Narrow Single Cladded Door in Oil Rubbed Bronze Finish

ALUMINUM DOORS

Aluminum Doors are Available in Many Different Styles Including an Adaptable Custom Design



Double Doors with PL 100 FS Panic Device



Double Aluminum Doors with Reflective Glass, Panic Hardware & PL-3 Offset Pulls

PRL GLASS SYSTEMS

(800) 433-7044

www.prlglass.com

ALUMINUM DOORS- *Configurations*

PRL aluminum Doors are top quality and functional, without compromising style. Aluminum Doors are available in many different styles including adaptable custom designs. Doors can be configured as single acting, double acting and accommodate top/bottom pivots, butt hinges, or piano hinges in conjunction with door hydraulic operators to function as center or offset hung. Our doors offer strong reinforced and welded corner construction for top performance that permits their use in heavy duty applications or oversize installations. Pairs of Doors are offered with standard meeting rails or special adjustable meeting rails for those difficult and out of square openings.

We offer aluminum doors in standard anodized and painted finishes. Combine your order with tempered or laminated glass, IG units, bullet resistant and you will receive a complete door package opening ready for fast and easy installation.



Narrow Stile
Horz muntin & beveled glass



Medium Stile
Matching stiles & muntin sizes



Custom Stile
Custom height w/ horz muntin



Wide Stile
SS Finish classic muntin pattern



Complete Entrance System with PRL Fabricated Storefront , Doors & IG Units with Reflective Glass

ALUMINUM DOORS- Custom Configurations



Curved Framing & Custom Doors with Horizontal Muntins



Custom Oversize Door with Ladder Pulls



Wide Stile Double Doors with Custom Height



Custom Wide Stile Doors with Muntins & Designer Texture Glass

ALUMINUM DOORS- Custom Configurations



Special Doors with Standard Muntins & Reflective Glass



Single Door with Hor./Ver. Muntins



Custom Laser Cut Aluminum Infill Panel



Doors w/ Wide Muntins & Curved Transom Frame

PRL GLASS SYSTEMS

(800) 433-7044

ALUMINUM DOOR - Door Hardware



Aluminum Doors and Storefront with Bronze 4569 Deadlatch

MECHANICAL LOCKS



AR1850
MS1850 deadlock



AR1850
MS1850 deadlock



AR4510
4510 series deadlatch



AR1890
1890 Dead Latch/Lock



AR4900
4900 Series Deadlatch

ALUMINUM DOOR - Door Hardware

MECHANICAL LOCKS



SCHAL
AI series latch lock



SCHND
ND series latch lock



SCHL9000
L series latch lock

LEVER



AR4560
4560 AR series deadlatch

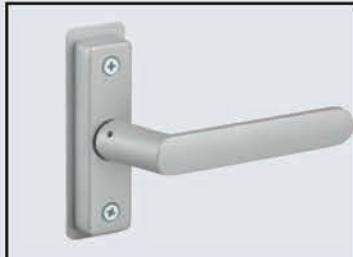

AR4568
4568 AR series deadlatch



AR4569
4569 AR series deadlatch

ELECTRIC STRIKES



AR7100
7100 AR electric strike



AR7400
7400 AR electric strike

PANICS



AR8600
8600 AR Series Exit Device



VDP9899
98/99 VD Series Exit Device



AR8800
8800 AR Series Exit Device



VDP3335
33/35 VD Series Exit Device

ALUMINUM BI-FOLD

Complete Accordion Bi-fold Aluminum Slider System a Versatile Solution for Any Application

Accordion Aluminum Bifold System



Accordion Bifold Slider with Hurricane Resistant Glass

**THERMALLY
BROKEN SLIDER**

PRL GLASS SYSTEMS

(800) 433-7044

www.prlglass.com

ALUMINUM BIFOLD- Configurations

Accordion

The great advantage of Bi-Fold Doors is that they can be easily stacked to one side, all in one motion, to create an unobstructed view. When closed, PRL Bi-Fold Doors provide superb sound control and excellent air and or water protection. They are thermally broken and available with hurricane impact rated glass. Join PRL in this new growing "Indoor/Outdoor Living" sliding door market and experience the advantages of allowing PRL to be your sliding door supplier.

Features

- Versatile
- Weather Resistant
- In-line / Multiple Panels
- Custom Configurations
- Thermally Broken
- Dual Tone Finish feature
- Dual Function Slide/Bifold



Bifold Slider with Reflective Glass

CONFIGURATIONS

- 2L
- 1L2R
- 3L1R
- 4L
- 2L2R
- 4L1R
- 3L3R
- 8R
- Custom



Note: 8 Panels maximum per side



PRL GLASS SYSTEMS

(800) 433-7044

www.prlglass.com

ALUMINUM BI-FOLD- Features



Accordion Bifold Slider with Custom Wood Grain Coat

STAINLESS STEEL HINGE



PRL's Accordion 316 stainless steel hinges provide higher weight capacity, strength, durability & performance

Still retained our exclusive unibody integral weather stripping raceway uncompromising our dual perimeter seal slider system.



FINISHES

Bi-fold are offered in several finishes to match or harmonize with most architectural or decor styles. Standard & custom finishes like custom color painted are offered upon request. Our double seal system allows to have two different types of finishes the interior vs the exterior. Custom finishes may present limitations, please Consult PRL for details.



Clear Anodized



Bronze Anodized



White Powder Coat and Custom Colors



Custom Graphic Wood Grain Coat. (Multiple Tones Available)



THERMALLY BROKEN SLIDER (Dual Tone Option)

PRL GLASS SYSTEMS

(800) 433-7044

www.prlglass.com

Accordion

Performance,
Safety & Sound
Reduction Glazing
Options



Residential Bi-fold with Low-E Glass IG Units



UNLIMITED GLASS OPTIONS

- IG Units
- Low E
- Reflective
- Dual/Triple Insulating
- Laminated
- Sandblast
- Texture



MULTI-POINT DOOR LOCK:

- Up to three Lock Point deadbolt
- Deadbolt, upward or downward shootbolt
- Lever Lock Set/Contemporary Handle Style



Bi-fold with Sandblast Border Design Glass

ALUMINUM BI-FOLD- Applications



Accordion Bifold System in White Powder Coat Finished



PRL GLASS SYSTEMS

(800) 433-7044

www.prlglass.com

Accordion



Multiple Bifold Systems with Low E IG Units



Accordion Bifold in Clear Anodized Finished

ALUMINUM SLIDER

Complete Max' Aluminum Slider System Ready to be Install

MAX'Sliders

PRL's MAX SLIDER Aluminum Multi-panel Sliding Door continues to gain confidence and growth in the sliding door market. Our versatile sliding system has become one of our best selling products with the option of top hung or bottom rolling system. The Max Slider provides superb sound control as well as excellent air and water protection, and is hurricane impact rated.



In-line Top Hung Max Slider with Slender Guides

MAXimum

- Efficiency & Durability
- Elegance
- Smooth Sliding
- Views
- Weather Tight
- Quality
- Strength (Hurricane Resistant)



PRL GLASS SYSTEMS

(800) 433-7044

www.prlglass.com

ALUMINUM SLIDER- *Top Hung & Bottom Roller Systems*

MAX'



Top Hung 90 Degrees Max Aluminum Slider with Slender Guides

CABO TOP HUNG ROLLERS

Top Hung Options:

- Center Lock Housing (for 1" Ultra Narrow Stile)
- Bug Screen Panel
- Floor Track Panel/Bottom Rail Dual Inset Guides



- Top Hung Roller (*150 lbs capacity EA)

CANCUN BOTTOM ROLLERS

Bottom Roller Options:

- Floor Track Panel/Bottom Rail Dual Inset Guides
- Quad Seal Floor Track
- Custom Sill pans available for water penetration resistance
- Beveled Nose (optional 1/2" or 3/4")

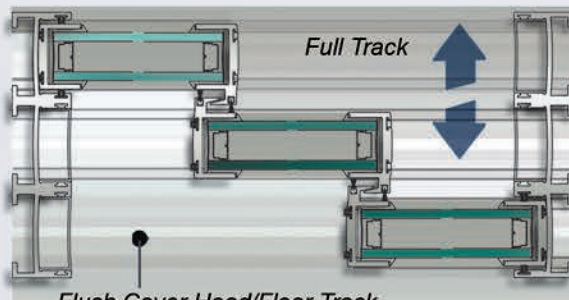
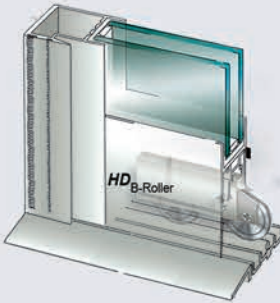

Flush Cover Head/Floor Track Inactive Sliding Guides



- Full Stainless Steel components.
- End adjustable under load.
- Will support a door weight up to 1000lbs.
- Composite wheels resist track wear.
- Reduced noise and smoother operation.

Bottom Rollers Max Aluminum Slider with IG Units

PRL GLASS SYSTEMS

(800) 433-7044

ALUMINUM SLIDER- Vertical Stiles



90 Degrees Max Aluminum Slider with Combination 3" & 1" Stiles

MAX'

Interlocking stiles create a moving wall that provides open spaces, easily closed by pulling only the leading panel. Multiple number of different rail and stile profiles are available including an "ultra-thin" 1" stile. Glass options include from 1/4" to 1-1/8" thick IG Units. Designed, extruded and manufactured in-house, this product is also LEED friendly and offered with our fastest lead time in the Industry!

CORNER STILE



1" ULTRA-NARROW

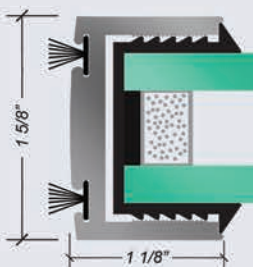

3" LOCKING STILE



90°

PRL GLASS SYSTEMS

(800) 433-7044

www.prlglass.com

ALUMINUM SLIDER- Pulls & Oversize Configurations



Oversize Max' Slider with Reflective Glass and an Aluminum Side Door

LOCK HARDWARE

Max Aluminum Sliding door locksets can be paired with standard flush escutcheons, luxurious stainless steel deep/bolder flush flush pulls, or custom pull hardware.

Pull sets in luxurious finishes are available, providing a balanced closing and opening effort on multiple panel systems.

**Custom sizes, technical/functional limitations apply. Handles are optional. Consult PRL for details*



4900 AR SERIES (AR4190)



DEEP FINGER / CANCUN



MAXI (M)



STANDARD FLUSH LOCKSET (SFL)*



LEVER ADA (LV)



MAGNETIC ADA (MAG)

ALUMINUM SLIDER- *Thermally Broken Applications*

MAX' //



Max Aluminum Sliders Hospitality Project



90 Degree Multi-Panel System

RETRACTABLE SCREEN

- Horizontally opening to simplify access with slide away technology
- No bottom threshold, sill or profile
- Exterior and interior installations
- Durable construction with top quality mesh
- Screens allow natural ventilation
- Save on air conditioning costs
- Simply clicks on and off for seasonal use
- Connecting living spaces, indoor to outdoor

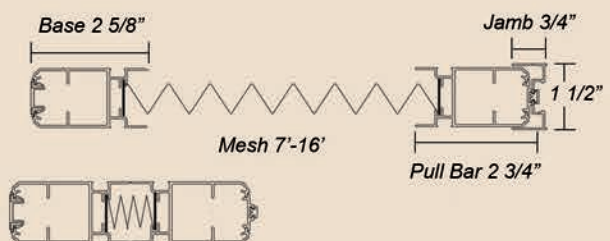

Finished Stack Width

PRL GLASS SYSTEMS

(800) 433-7044

www.prlglass.com

ALUMINUM SLIDER- Applications

MAX'



In-line & 90 Degree Max Sliders Systems with IG Units



Biparting Ultra Narrow Max Slider with Low E Glass

PRL GLASS SYSTEMS

(800) 433-7044

www.prlglass.com

ALUMI SLIDER

Lighter Weight High Quality Modern Interior Aluminum Slider



In-line Top Hung Max Slider with Slender Guides

PRL manufactures a wide selection of sliding door systems. Our Alumi-Sliders are an attractive, and cost effective solution for interior applications where space can be maximized and security and privacy can be maintained. PRL Alumi-Sliders are a lighter weight, high quality aluminum sliding door suitable for modern office or retail spaces, restaurant moveable wall partitions or residential room dividers.

A variety of configurations are available including pocket doors or multi panel units. Inter-locking stiles allow for easy opening and closing of several panels with one motion. PRL's wide selection of glass types provide endless options for creating your own unique design. Choose from a variety of rail sizes, optional horizontal mullions, and metal finishes to satisfy to suit your décor requirements. Please contact PRL Aluminum for quotes or information on our Alumi-Sliders or any of our sliding entry systems.

TOP HUNG:

Vertical View:

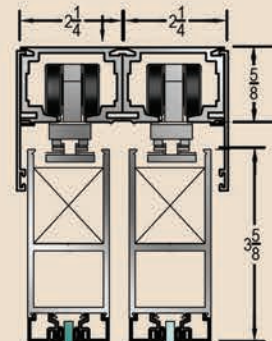

Track View:

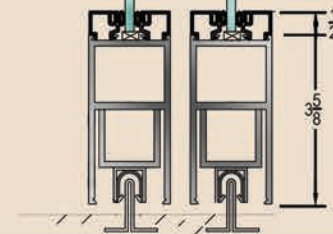
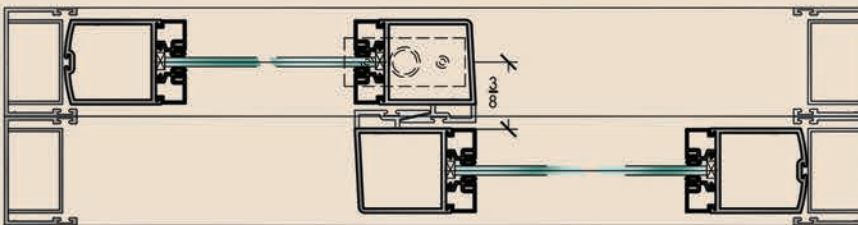

PRL GLASS SYSTEMS

(800) 433-7044

www.prlglass.com

ALUMI SLIDER- Top Hung & Bottom Roller Systems



In-line Top Hung Alumi Slider with Sandblast Glass

FEATURES:

- 2" Rollers
 - Max weight cap. 220lbs per roller
- We can match any size top or bottom rail (up to 10")
- Size limitations 60" x 108"
- Interior application only
- Top hung or Bottom roller
- Muntin Bars

GLASS OPTIONS:

- 1/4", 3/8" 1/2" & 1"
- Tempered
- Laminated
- IG Units

DOOR STILES:

- Narrow Stile- 2"
- Medium Stile- 3 1/2"
- Wide Stile- 5 1/8"

BOTTOM ROLLED:

Vertical View:

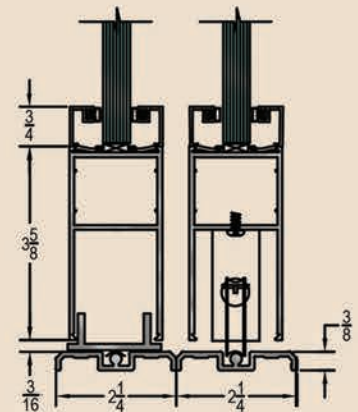
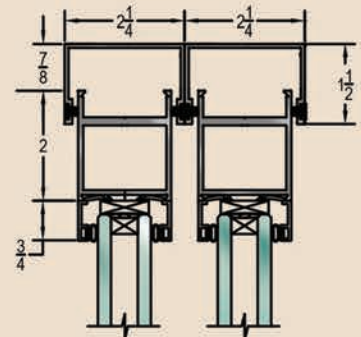

Track View:

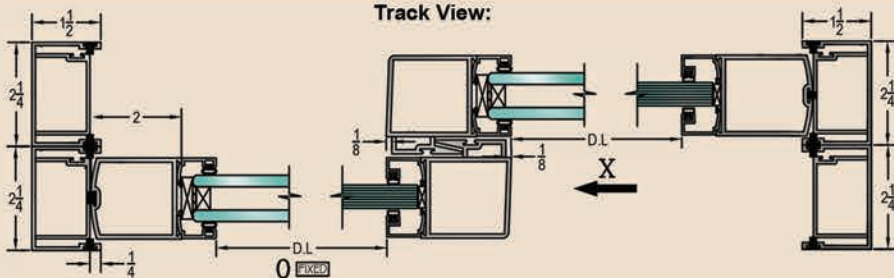

RUBY ALL GLASS SLIDER

Contemporary and Elegant Interior Top Hung Stainless Steel Sliding System



Glass Mount Ruby Slider System with Short Ladder Pull

PRL GLASS SYSTEMS

(800) 433-7044

www.prlglass.com

RUBY ALL GLASS SLIDING SYSTEM- Configurations

Wall Offset Surface Mount

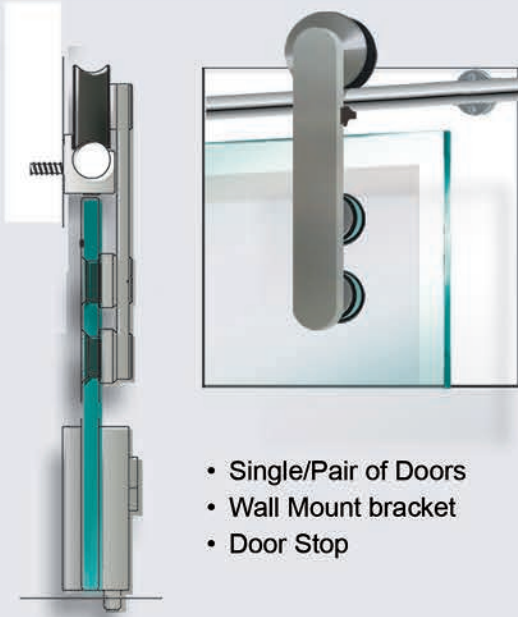

- Single/Pair of Doors
- Wall Mount bracket
- Door Stop



Dual Function Wall Mount Residential Ruby Slider



Office Glass Mount Ruby Slider with Custom Sandblast

Glass Mount

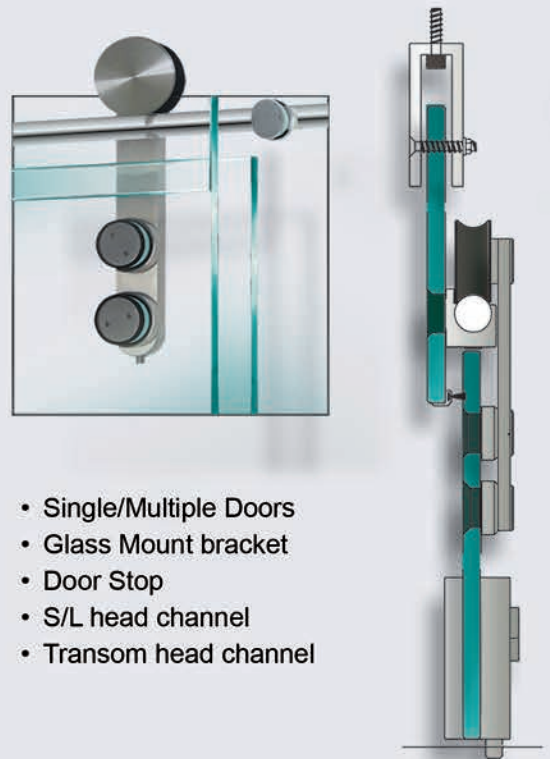

- Single/Multiple Doors
- Glass Mount bracket
- Door Stop
- S/L head channel
- Transom head channel

TIFFANY ALL GLASS SLIDER

Top Hung Sliding Unit Slides Effortlessly Using Only Two Small Suspension Points



Office Tiffany Slider System Double Doors with Custom Sandblast Design & Square Locking Ladder Pulls

TIFFANY ALL GLASS SLIDING SYSTEMS- *Features*



CONFIGURATIONS

- Single Pocket
 - Hidden Pocket
 - Lateral Surface mount
- Door/Fixed Panel

MOUNTING OPTIONS

- Top Hung
 - Concealed/exposed
- Lateral
 - Surface mount

HARDWARE

- Flush Mount
 - Finger Pull
- Concealed Door Stop
- Floor Guide



Multiple Tiffany Sliding Systems with Easy Lock Ladder Pull



Conference Room Tiffany Sliding System

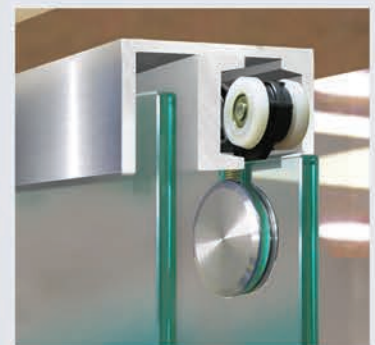

Top Hung Slider Door/Sidelite
2 3/8" Diameter Bracket

QUARTZ ALL GLASS SLIDER

Accommodate Doors Making them Ideal for Businesses, Residential or Commercial



Ceiling Mount Quartz All Glass Slider with Lader Pulls

PRL GLASS SYSTEMS

(800) 433-7044

www.prlglass.com

QUARTZ ALL GLASS SLIDING SYSTEMS- Features



Ceiling Mount Quartz All Glass Slider with Tinted Glass

TOP HUNG SLIDING DOORS

- Track Can Be Mount on a Wall or Ceiling
- Sliding Track With Rollers Hidden Inside
- Glass Safety Hung by Clamps
- No Special Glass Fabrication
- Soft Closing Mechanism
- Glass Thickness Adjustable (3/8- 1/2)
- Soft Closing Mechanism Reduces the Speed of Closing Doors. Lets Them Slide Quietly



Track View



Soft Closing Mechanism



Ceiling Mount with Sidelite

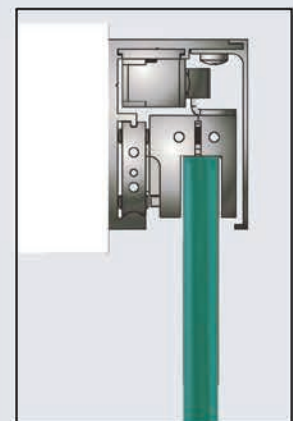

Wall Mount

PRL GLASS SYSTEMS

(800) 433-7044

www.prglass.com

CLEARVISION MOVABLE WALL SYSTEM

Top Hung Movable Glass Wall System Provides Great Design Flexibility When the Design Intent is to Maintain a Secure but Transparent Entry that Will Allow For a Partial or Complete Unobstructed



Movable All Glass Top Hung Slider/Stacking Door System



All Glass Stacking Multiple Panels System / Swing Doors Function

PRL GLASS SYSTEMS

(800) 433-7044

www.prlglass.com

CLEARVISION SLIDING SYSTEMS- Configurations



Clearvision All Glass Slider, Swing, Stacking Door System

• Single/Multiple Panels

• Dual Swing / Sliding

• In-line or Stacking



PRL GLASS SYSTEMS

(800) 433-7044

www.prlglass.com

CLASSIC SLIDING SYSTEM

Providing Strength and Beautiful Solutions for Practically Any Exterior or Interior Application



P Style Bottom Roller Sliding Doors & Frameless Sidelites

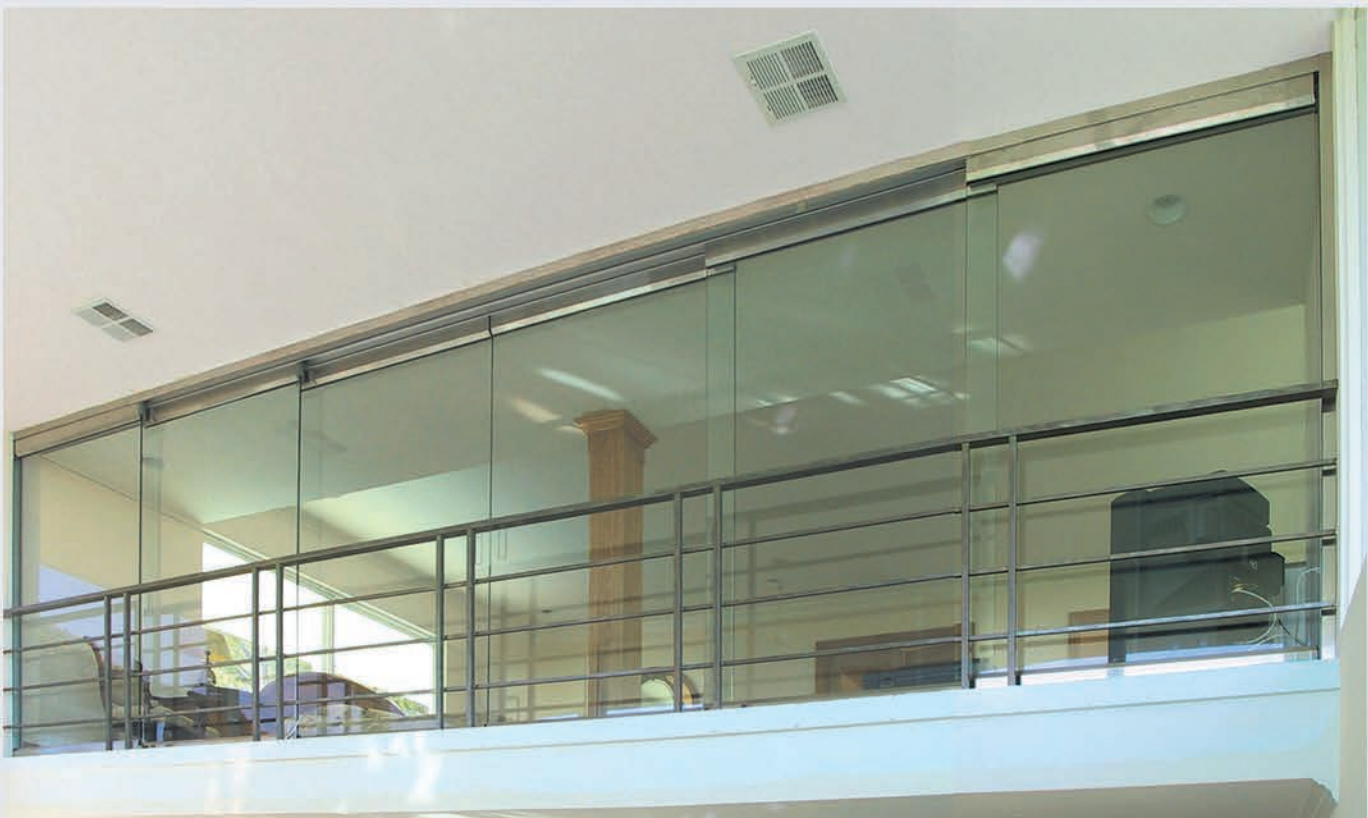

P Style Bottom Roller Multipanel Sliding Doors/Sidelite System

PRL GLASS SYSTEMS

(800) 433-7044

www.prlglass.com

CLASSIC SLIDING SYSTEMS- Features



Double Doors Sliding System with Top and Bottom Sliding Tracks

BOTTOM ROLLERS SYSTEM

PRL Sliding Systems offer unlimited options wherever valuable space and exposure is critical with:



PRL GLASS SYSTEMS

(800) 433-7044

CLASSIC FULL FRAME SLIDING SYSTEM

The Beauty of a Uniquely and Elegant Door System in Stainless Steel Enhances Any Room



Stainless Steel Full Frame Sliding System with Sound Control Glass

PRL GLASS SYSTEMS

(800) 433-7044

www.prlglass.com

FULL FRAME SLIDING SYSTEMS- Features



Double Panel Full Frame Sliding System with Bottom Sliding Tracks



One Panel Full Frame Sliding System in Stainless Steel

BOTTOM ROLLING SYSTEM

- Interior Applications Only
- Without Glass Stops
- Unlimited Glass Options
- Glass thickness 1/4" to 1"
- Luxurious Cladded Finishes
- Two Roller Weight Capacity up to 1000 lbs



Bottom Rolling System

COMPLETE SHOWER / STEAM UNITS

Offer an Elegant Accent to the Bath Environment and Enhances Custom Tile or Marble Work

Nu vision frameless units features:

- Hinge/Pivot Swing or Slider Doors
- Clear, Textured or Sandblast Glass
- Water/Steam Tight Seals
- Tempered Safety Glass
- Custom Glass/Metal Fabrication
- 3/8" or 1/2" Glass



90 Degree Shower Unit with Movable Transom Panel

PRL GLASS SYSTEMS

(800) 433-7044

www.prlglass.com

SHOWER / STEAM UNITS- Configurations



Single Door Shower Unit with Starphire Glass



90 Degrees Shower Unit with Shower Glass



Oversize Mirror and 135 Degree Shower Unit with Diamond Seal Coating Glass

SHOWER DOORS- *Knobs & Pulls*

PRL offers a complete and exclusive line for SD Pulls. Illustrated hardware is PRL's standard SD Knobs and Pulls, which offer significant design flexibility and are available in several standard finishes to choose from.

PRL Pulls Features:

- 3/4" Brass Tubing or Solid Bar
- 3/8", 1/2", Glass Mount
- 6", 8" Size*
- 18", and 24" Towel Bar

Available finishes are:

- Polished Chrome
- Oil Rubbed Bronze
- Brushed Nickel

Applications include back to back, single mount pull/towel bar etc.



Neo-Angle Shower Unit with Bow Knob



PL-KNOB - Standard



PL-BSK - Bow

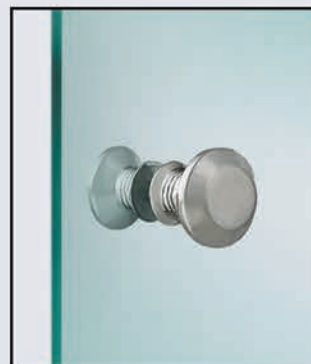

PL-BK - Beverly



PL-KDD - Knobs

PRL GLASS SYSTEMS

(800) 433-7044

www.prlglass.com

SHOWER DOORS- *Knobs & Pulls*



Inline Shower Unit with Square Ladder Pull



Double Doors Shower Unit with Ladder Pulls



PL3SD6 - Standard(6")



PL-SQ8X8- Square



PL-CTP - Contemporary (8")



PL-MLP - Mini Ladder (8")

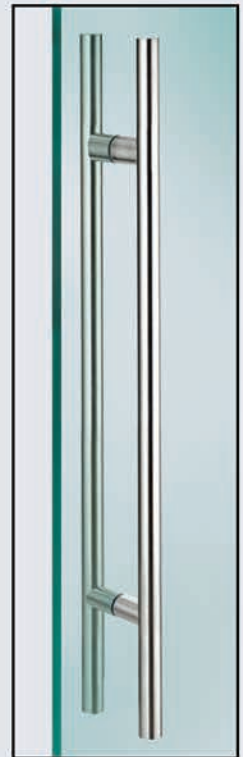

PL-LADDER - Ladder

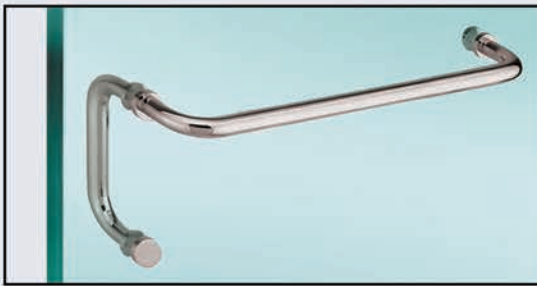

PL-8SD618 - Standard Combo (6"/18" or 6"/24")

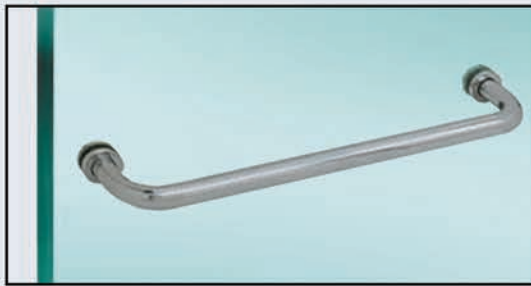

PL-18SSTBBN - Single Towel Bar (18" or 24")

SHOWER DOORS- Hinges & Clamps



90 Degree Unit with Header and Top/Bottom Pivot

Nu Vision Shower units are made functional with the use of a variety of fully engineered Pivot/Hinges.

Available finishes are:



Brushed Nickel



Polished Chrome



Oil Rubbed Bronze

Applications include wall mount, glass to off-angle, glass to glass, etc.

SAMSON DOOR CLOSER / PATCH

Now available for shower enclosures

PL-424BS
Top Patch

PL414-HYHD
Door Closer/Patch



BELLA



PL-TBHD044CH
Offset BPWM



PL-TBHD045CH
135° GG



PL-TBHD180CH
180° GG



PL-TBHD074CH
Short BPWM

TB PIVOT



PL-ABCGTC
Bottom Pivot



PL-ABCGTH
Pivot Hinge w/ Header Adaptor*

*Header available consult us for details

SYDNEY



PL-TSHD044CH
Offset BPWM



PL-TSHD045CH
135° GG



PL-TSHD180CH
180° GG



PL-TSHD074CH
Short BPWM



PL-TSHD037CH
Full BPWM

SAMSON



PL-SAMSONCH
180° GG (Chrome only)

SHOWER DOORS- Hinges & Clamps

CONTOURED Hinges Clamps



PL-CWMCH Short BPWM
 PL-C045CH 135° GG
 PL-C180CH 180° GG
 PL-CTC188CH 180° GG
 PL-CTC186BN Movable WM
 PL-CCCH WM

SADE Hinges Clamps



PL-TS074BN Short BPWM
 PL-TS045CH 135° GG
 PL-TS180CH 180° GG
 PL-TS044CH Offset BPWM
 PL-TSC188CH 180° GG
 PL-TSC186CH Movable WM
 PL-TSCBN WM

BEVERLY Hinges SLEEVE OVER Clamps



PL-TB044CH Offset BPWM
 PL-TB074BN Short BPWM
 PL-90SOCH 90° Over Glass
PL-TB045CH 135° GG
 PL-TB180CH 180° GG
 PL-135SOCH 135° Over Glass

Clamps



PL-TBC180CH Fixed
 PL-TBC188CH Movable Tram.
 PL-TBC90CH 90° Fixed GG
PL-TBC135CH 135° Fixed GG
 PL-TBCCH Fixed WM
 PL-TBC186CH Movable WM



In-Line Unit with Beverly Series 180° Hinge and Clamps

SHOWER DOORS- Glass Fabrication



Custom Wave Top Shower Unit with Standard Pull



Custom Curved Top Shower Units with Sandblast Glass



Custom Exterior Shower Units with Acid Etch Glass

SHOWER DOORS- *Glass Fabrication*

PRL custom glass fabrication on showers and steam units will meet the most creative design concepts and intricate field conditions.

ONE PIECE CUSTOM GLASS!



Custom Shower Unit with One Piece Acid Etch Texture Glass



CUSTOM VENT CUTOUT



CUSTOM TRANSOM CUTOUT



OCEAN SURF TOP



CORNER CUTOUT
DETAIL



TILE NOTCH



SANDBLASTED ARCHED TOP



CUSTOM
SANDBLAST
GLUECHIP

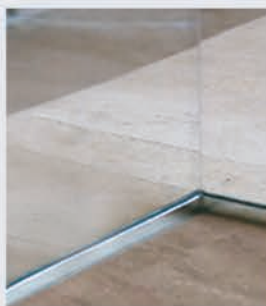

SEAMLESS
MITER CORNER



WAVE TOP

CONTOURED SHOWER SLIDER

The Most Popular Tub and Shower Slider, You Don't Have to Sacrifice Beauty for Practicality

Glass is offered in 3/8" with options in,

- Clear Glass / Tinted Glass
- Pattern Texture Glass
- Custom Sandblasted Glass

Available finishes are:

- Bright-Dip Clear Anodized
- Oil Rubbed Bronze
- Brushed Nickel

Standard Hardware:

- Single Towel Bar/Singles Knob



Shower Slider in ORB Finish with Texture Glass



Shower Slider with 3/8" Starphire Glass in Brushed Nickel Finish



Bright-Dip Anodized Shower Slider with Towel Bar

PRL GLASS SYSTEMS

(800) 433-7044

www.prlglass.com

FRAMELESS SHOWER SLIDER

Frameless, Trendsetting Design and an Smooth, Effortless Operation

PRL has what you're looking for- our 3/8" Ruby and Tiffany shower door sliders! These stunning all-glass shower sliders will take your breath away with their frameless, cutting-edge design. Multiple 3/8" glass options to choose from and easy, smooth operation.

Features:

- Modern 4-wheel roller system
- Easy and smooth sliding operation
- Multiple 3/8" glass options
- Maximum door weight: up to 130 lbs.
- Support Bar: up to 60"

3 Different Hardware Finishes



Oil Rubbed Bronze



Brushed Stainless Steel



Polished Stainless Steel

RECTANGULAR SLIDING TRACK



Tiffany Shower Slider in Oil Bronze Finish



Sample shown in BSS

ROUND SLIDING TRACK



Ruby Shower Slider with Starphire Glass



Sample shown in ORB

PRL GLASS SYSTEMS

(800) 433-7044

www.prlglass.com

COMPLETE HANDRAIL SYSTEMS

PRL Offers Contemporary Railing Systems Options, Components as well as Custom Fabrications



Elegante Handrail System with Flat Cap Standoffs

PRL GLASS SYSTEMS

(800) 433-7044

www.prlglass.com

HANDRAIL/GUARDRAIL SYSTEMS- Complete Systems

Rapid Dry-set

Precision Bolt Assembly



Elegante Stand-off

Offset Surface Mount

Infinity Floor Post Mount

Modular System



Flex Post

Multiple Applications

Traditional Wet-set

High Compression Wet Glazed



Gates/Fencing

Laminated Glass

GUARDRAIL/HANDRAIL SYSTEMS- Top Caps

BRAKEFORMED ROUND



PL- TCBS

SQUARE

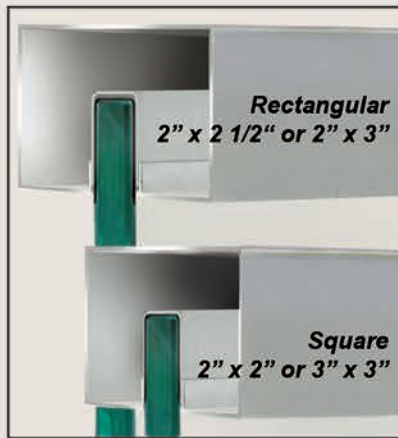

PL- SQTC

Stainless Steel Finishes
(Brake-Formed Clad)
8 Polished, #4 Satin

Naval Brass
Polished & Satin

EXTRUDED ALUMINUM



PL-ATC

Extruded Aluminum Finishes:
Mill, Clear and Bronze
Powder Coat
White

We also offer custom fabrication, machining and finishing services, as well as variety of standard & custom components.



Handrail/Guardrail Glass System with Square Top Cap

HANDRAIL/GUARDRAIL SYSTEMS- *Rapid Dryset 4" & Mini Mighty 2 3/4"*

New Features:

- Drop in cover plate with vinyl included for unique faster glazing solution
- 35% Lighter vs the traditional shoe base
- Screw raceway design for alignment pin and end cap attachment

Other:

- Dry-set bolt assembly
 - Time and labor saver
 - No special tools required
- Can be used dry/wet glazed
- 10' & 20' Stock Lengths
 - Custom lengths available

FEATURING



Round & Square top Caps

Laminated or Tempered Glass

Cladding

Drop-in Cover with Vinyl

Screw raceway design for alignment pin

3" Sectional pressure Plate for DrySet

Bolt Assembly

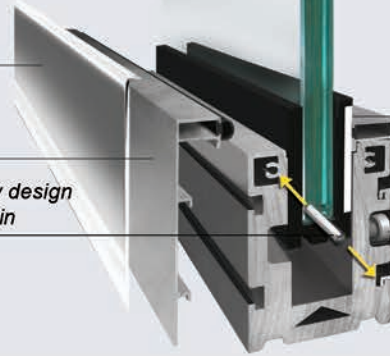

ALL COMPONENTS ARE SOLD SEPARATELY:



Cladding

- Polished/Brushed Stainless Steel
 - Polished/Brushed Naval Brass*
- *No lacquer



Drop in Cover

- Mill Finished
- Clear Anodized
- Bronze Anodized
- Powder Coat

Shoe Base

Aluminum Mill Finish Cover



2 3/4" Height



4" Height
(1/2 or 3/4 glazed)



3" Sectional Pressure Plate for Dry-Set only

*Standard Base comes w/ Mill Finish Covers



Rapid Dryset 4" Guardrail System with Sentry Laminated Glass

PRL GLASS SYSTEMS

(800) 433-7044

www.prlglass.com

HANDRAIL/GUARDRAIL SYSTEMS- Glass & Wall Mount Brackets



PL- HR20XDWBS
Adjustable Wall Mount
Bracket for 1 1/2" Dia Tubing



PL- HR20XCGPS
Wall/Glass Mount Bracket
for 1 1/2" Dia. rail

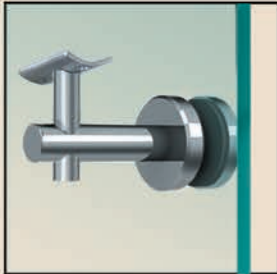

PL- HR20XEGPS
Adjustable Glass Mount
Bracket for 1 1/2" Dia Tubing

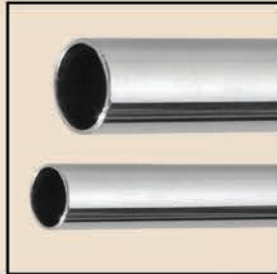

PL- HR15
1 1/2" Dia. / 2" Dia.
HR Round Tube

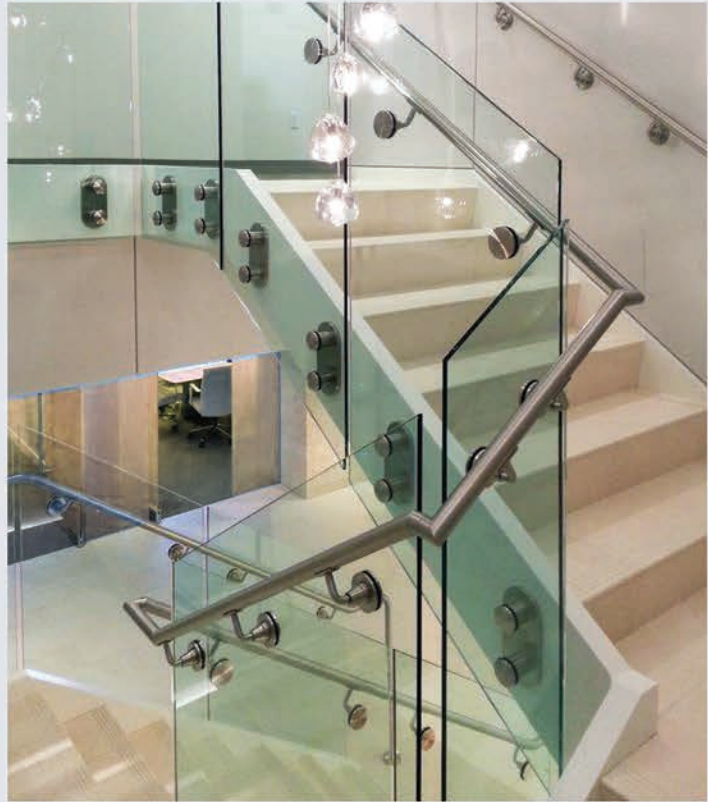

Handrail System with Glass Mount Brackets



Stand-off Handrail System with Glass Mount Brackets for Round Offset Tubular Bar

HANDRAIL/GUARDRAIL SYSTEMS- Elegante Handrail Components



Elegante Stand Off System with Laminated SentryGlas®



PL-RS0BD20BS
4" w x 8" h SQ. Corners
Round/Flat Cap



PL-R2SOBD20BS
Round Mount Bracket
for 2" Standoff



PL-RSOB2134BS
2" Dia.
SQ / Round Cap

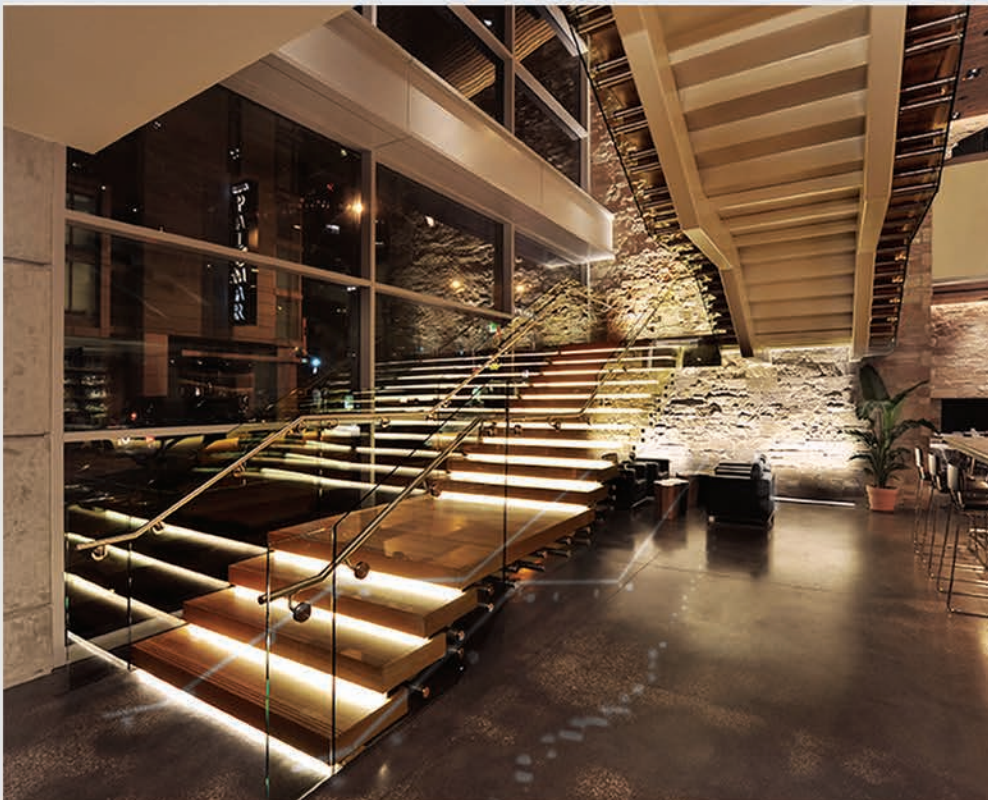

Custom Length Standoff Bracket and Flat Caps



Custom Length Standoff

HANDRAIL/GUARDRAIL SYSTEMS- *Infinity Floor Post Mount*

Aluminum Modular Railing

Offering, easy installation solutions & the best systems in the industry! For 1/4" and 3/8" glazing.

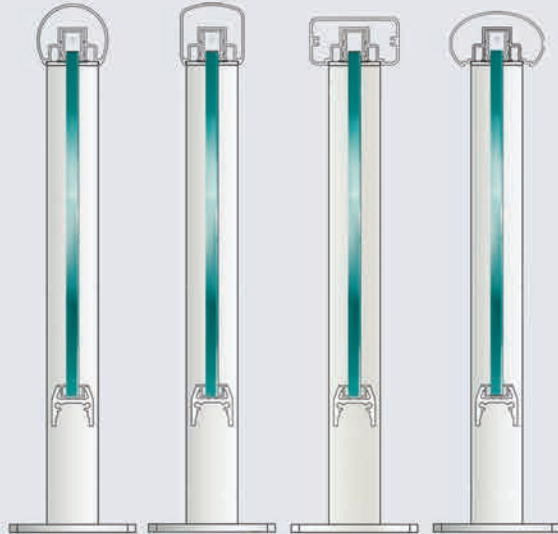

Series 200 250 300 350



Infinity Handrail Project



Infinity Aluminum Modular Floor Mount Handrail System with Laminated Glass

PRL GLASS SYSTEMS

(800) 433-7044

www.prlglass.com

HANDRAIL/GUARDRAIL SYSTEMS- *Flex & Custom Post*

PRL's Stainless Steel Flex Custom Post is just that "flexible", and our adjustable stand-offs can easily adapt to special angles on your job conditions, while enhancing the appearance of your project with elegance and style. With our in-house full capacity metal fabrication capabilities, we can create Custom Posts to any height, shape and form with maximum accuracy, durability, and superb craftsmanship.

Accessories available for Custom HR/GR Systems:

- Custom Post
- Wall & Glass Mount Brackets
- Oversize/Custom Glass Fabrication
- Laminated Glass Options offer unlimited aesthetic & safety features



PRL Fabricates Custom Posts In-House based on Customer's Requirements



Custom Post Handrail Series with Sentry Laminated Glass

PRL GLASS SYSTEMS

(800) 433-7044

www.prlglass.com

CUSTOM GATES

PRL Offers a Variety of Glass and Metal Gate/Fencing for Standard and Custom Applications

PRL Glass gates add a contemporary option to access control for residential or commercial applications. Our Glass and Aluminum Gates combine the best qualities, of aesthetic transparency, privacy and security. The transparency of glass is a wonderful way to showcase beautiful gardens, pools, views or property structures and our hardware selection offers security options with euro lock/lever handles, strikes, fittings or adaptable centerlock housings.

We provide complete glass gates and fences, fabricated to your specifications in our facility and delivered ready to install.



Access Gate with Acid Etch Glass



Custom All Glass Fence/Guardrail System



Beach Access Gate with Centerlock Housing

**Specialty hardware
available!**

- Latch Lock/Lever Handles
- Electric/Mechanical Access Devices



Glass Gate with CLH Glass/ Digital Key-Pad

PRL GLASS SYSTEMS

(800) 433-7044

www.prlglass.com

GATES- All Glass, Stainless Steel & Aluminum Applications



Full Frame Gates with Textured Laminated Glass



Custom Access Gate with Centerlock Housing



Aluminum Gates with White Rainbow Color Laminated Glass



Security Gate with Custom Strike Application



Security Access Gate



Access Control Gate with Sandblast Design Logo

STOREFRONT SERIES

Complete Glass and Metal Systems Ready to Install



250 Series Entrance System with Custom Arched

PRL GLASS
SYSTEMS

(800) 433-7044

www.prlglass.com

STOREFRONT ALUMINUM SYSTEMS- *Features*



Custom Storefront Doors with Custom Pulls

- Complete Fabricated Systems
- Stock Lengths Available
- Shop Drawing Services
- All Hardware Options Available
- Unlimited Glass Options:
 - Clear
 - Textured
 - Tinted Uncoated
 - Spandrel
 - Sentry
 - Low E
 - Sandblast
 - Reflective
 - Laminated
 - Custom

STOREFRONT SERIES

- 201** 2" x 4 1/2"
1/4" Offset Glazed
- 250** 2" x 4 1/2"
1" Center Glazed
- 251** 2" x 4 1/2"
1" Offset Glazed
- 400** 1 3/4" x 4"
1/4" Center Glazed
- 401** 1 3/4" x 4"
1/4" Offset Glazed
- 450** 1 3/4" x 4 1/2"
1/4" Center Glazed



250 Series Entrance System with Full Height Ladder Pulls

STOREFRONT ALUMINUM SYSTEMS- *Interior Applications*



Aluminum Door/Framing with Clear & Acid Etch Glass



201 Series Custom Storefront with Spandrel and Clear Glass

STOREFRONT ALUMINUM SYSTEMS- *Exterior Applications*



250 Series with Vistacool Reflective Glass IG Units



250 Series with Coastal Custom Paint

STOREFRONT ALUMINUM SYSTEMS- *Offset Glazed Series*

201 SERIES
2" x 4 1/2"
1/4" Offset Glazed

251 SERIES
2" x 4 1/2"
1" Offset Glazed

401 SERIES
1 3/4" x 4"
1/4" Offset Glazed

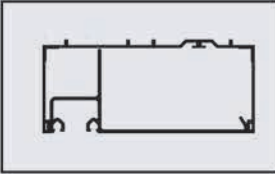
HEAD NAME PART NUMBER LENGTH	
	HEAD ASSEMBLY
	201HCA 24'-1"

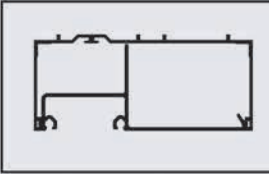
HEAD NAME PART NUMBER LENGTH	
	HEAD ASSEMBLY
	251HCA 24'-1"

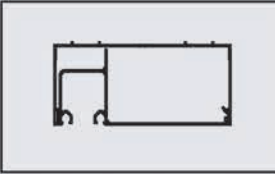
HEAD NAME PART NUMBER LENGTH	
	HEAD ASSEMBLY
	401HCA 24'-1"

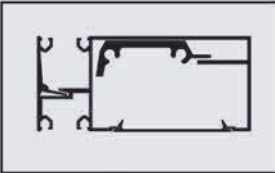
HORIZONTAL NAME PART NUMBER LENGTH	
	HZ ASSEMBLY
	201HMA 24'-1"

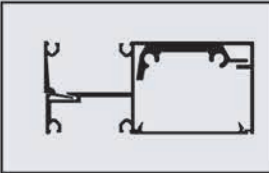
HORIZONTAL NAME PART NUMBER LENGTH	
	HZ ASSEMBLY
	251HMA 24'-1"

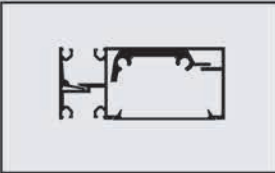
HORIZONTAL NAME PART NUMBER LENGTH	
	HZ ASSEMBLY
	401HMA 24'-1"

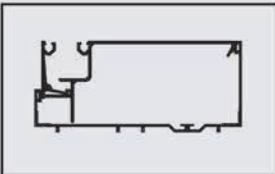
SILL NAME PART NUMBER LENGTH	
	SC ASSEMBLY
	201SCA 24'-1"

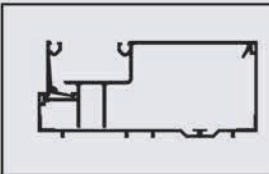
SILL NAME PART NUMBER LENGTH	
	SC ASSEMBLY
	251SCA 24'-1"

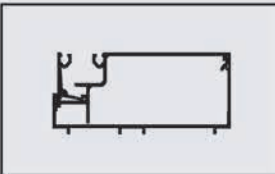
SILL NAME PART NUMBER LENGTH	
	SC ASSEMBLY
	401SCA 24'-1"

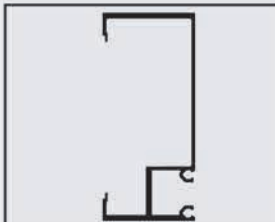
JAMBS NAME PART NUMBER LENGTH	
	WALL JAMB
	201WJ 24'-1"

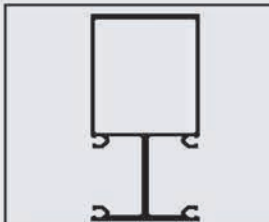
JAMBS NAME PART NUMBER LENGTH	
	VERTICAL MULLION
	251VM 24'-1"

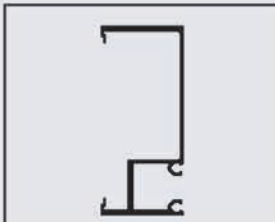
JAMBS NAME PART NUMBER LENGTH	
	WALL JAMB
	401WJ 24'-1"

MATERIAL: 6063-T5 aluminum alloy.

FINISH: Standard finishes are mill, clear and bronze anodized. All others are special order.

NOTES: Storefronts are available in quick set or screw race, please consult PRL aluminum for details

STOREFRONT ALUMINUM SYSTEMS- Center Glazed Series

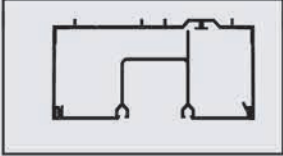
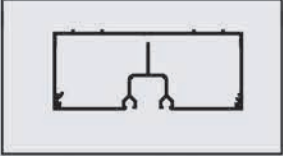
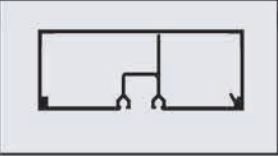
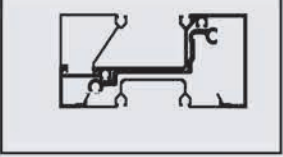
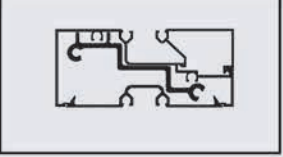
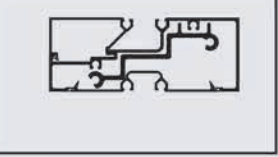
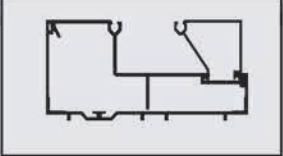
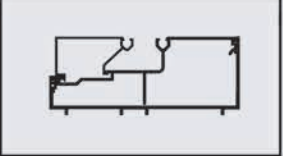
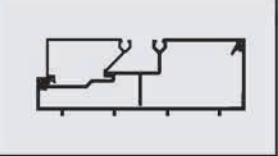
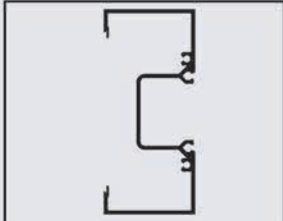
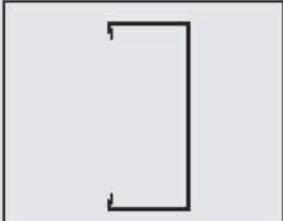
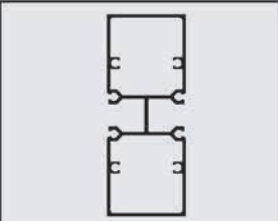
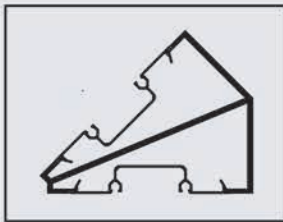
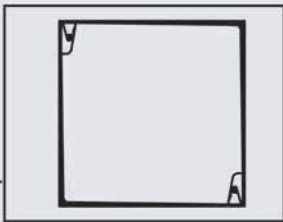
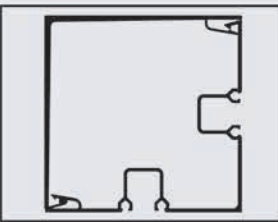
	250 SERIES 2" x 4 1/2" 1" Center Glazed		400 SERIES 1 3/4" x 4" 1/4" Center Glazed		450 SERIES 1 3/4" x 4 1/2" 1/4" Center Glazed
HEAD		HEAD		HEAD	
NAME	HEAD ASSEMBLY	NAME	HEAD ASSEMBLY	NAME	HEAD ASSEMBLY
PART NUMBER	250HCA	PART NUMBER	400HCA	PART NUMBER	450HCA
LENGTH	24'-1"	LENGTH	24'-1"	LENGTH	24'-1"
HORIZONTAL		HORIZONTAL		HORIZONTAL	
NAME	HZ ASSEMBLY	NAME	HZ ASSEMBLY	NAME	HZ ASSEMBLY
PART NUMBER	250HMA	PART NUMBER	400HMA	PART NUMBER	450HMA
LENGTH	24'-1"	LENGTH	24'-1"	LENGTH	24'-1"
SILL		SILL		SILL	
NAME	SC ASSEMBLY	NAME	SC ASSEMBLY	NAME	SC ASSEMBLY
PART NUMBER	250SCA	PART NUMBER	400SCA	PART NUMBER	450SCA
LENGTH	24'-1"	LENGTH	24'-1"	LENGTH	24'-1"
JAMBS		JAMBS		JAMBS	
NAME	WALL JAMB	NAME	DOOR JAMB	NAME	VERTICAL MULLION
PART NUMBER	250TJ	PART NUMBER	400DJ	PART NUMBER	450VM
LENGTH	24'-1"	LENGTH	24'-1"	LENGTH	24'-1"
135 CORNER POST		FLAT CORNER POST		DUAL POCKET CORNER POST	
NAME	135 CPOST	NAME	FLAT CORNER POST	NAME	CORNER POST (2P)
PART NUMBER	250NCPA	PART NUMBER	400FCPA	PART NUMBER	450DBCP
LENGTH	24'-1"	LENGTH	24'-1"	LENGTH	24'-1"

MATERIAL: 6063-T5 aluminum alloy.

FINISH: Standard finishes are mill, clear and bronze anodized. All others are special order.

NOTES: Storefronts are available in quick set or screw race, please consult PRL aluminum for details

ALUMINUM CURTAINWALL

Designed and Engineered for Maximum Performance



PLCW-600 Series with Low E Clear Glass IG Units

PRL Aluminum Curtain Wall Systems (PL-CW600, 700 and 1000) offer a structural solution when standard storefront is insufficient to meet size and load requirements. Our Curtain Wall is designed and engineered for maximum performance and highest quality assurance. We offer complete systems including doors, sub-frames, hardware and glazing.

- Aluminum Framing/All Glass
- Custom Extrusions
- Complete Storefront System
- CNC Fabrication
- Hardware
- Custom Breakmetal
- Architectural Glass
 - IG Units
 - Tempered Glass
 - Spandrel
 - Reflective Glass



PLCW-700 with SN68 Super Neutral Glass



PLCW-600 Series with Pacifica Tinted Glass

CURTAINWALL SERIES

- PLCW-600 - 2 1/2" x 6"
1" Offset Glazed
- PLCW-700 - 2 1/2" x 7"
1" Offset Glazed
- PLCW-1000 - 2 1/2" x 10"
1" Offset Glazed

PRL GLASS SYSTEMS

(800) 433-7044

www.prlglass.com

ALUMINUM CURTAINWALL- Features



Curtainwall with 1/4" Solarban® 60 Low-E and Atlantica IG Units



Curtainwall with Tinted & Spandrel Glass

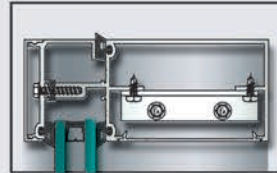

HEAD

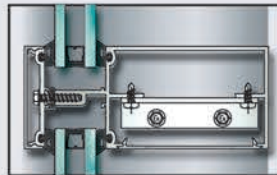

HORIZONTAL

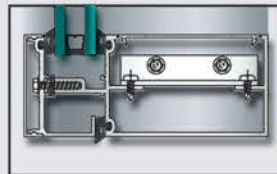

SILL



Curtainwall System with Reflective Glass

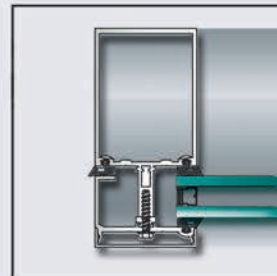

JAMBS

Features

- Versatile
- Structural
- Energy efficient
- Custom design
- Fastest design/mfg

ALUMINUM EXTRUSION

We Can Extrude Custom Aluminum Profiles

Capabilities:

- PRL specializes in 6,000 series alloy & inventories 6063, 6463 and 6061 in a variety of tempers.
- Extrude heavy weight shapes up to 10 lbs./ft. with PRL's powerful 2400-ton press, depending on alloy
- Accommodate up to 9 1/2" diameter shapes.
- Accommodate custom & standard circle shapes from as little as 3/8" to 10".
- Exceptional hollow shape capabilities! We hold tight tolerances and maintain uniform wall thicknesses.
- Accommodate lengths up to 55 feet with our over size aging oven.
- Special lengths per our customer's specifications, reduced waste. PRL passes the savings onto our customers!

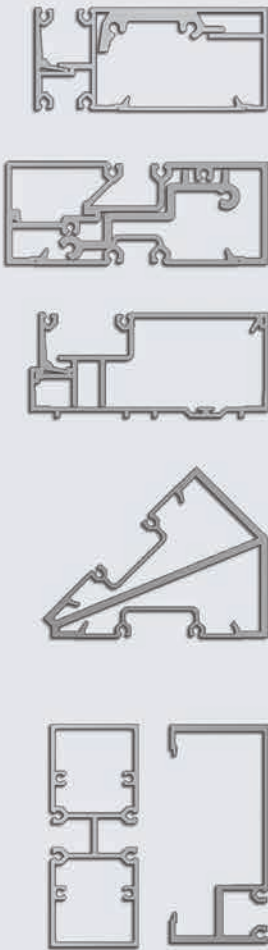

PLCW-700 Curtainwall with Reflective Glass

PRL GLASS SYSTEMS

(800) 433-7044

www.prlglass.com

BREAKMETAL

Custom Form Metal Profiles

Clad

- Full Frame Doors
- Storefront Framing
- Column Covers
- Cornices
- Panel Pans
- Top Caps
- Miter Returns/Corners
- Corners
- Connectors



Full Frame Doors & Storefront Framing Clad in Stainless Steel

Metal Finishing

- Mirror Polishing
- Directional
- Satin Brush

Brakeformed Shapes



•Corner



•L-Angle



•Z-Shape

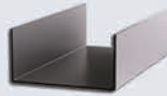

•U-Shape



•Hat



•Close-U



Custom Shapes

Full Frame Doors and Framing Clad in #8 Polished Stainless Steel

PRL GLASS SYSTEMS

(800) 433-7044

www.prlglass.com

IF SPEED MATTERS!
 We offer the Fastest Leadtimes
 *Consult PRL for details

We are only a simple click away
Quick Order & Quotes Online
 at **PRL Glass & Aluminum**



Custom Interior Applications Oversize Wine Cellar



Accordion Bifold Slider with IG Unit



1/4" Solarban® 60 Low-E Glass



Max Aluminum Slider with Low-E Glass



Laminated Bullet Resistant Glass